

# CAS/CASR/CKSR series Current Transducers

Insulated Highly Accurate Measurements  
from 1.5 to 50 A<sub>RMS</sub>

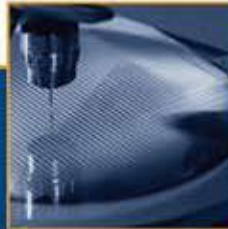

Future precision.  
Future performances.  
Now available.

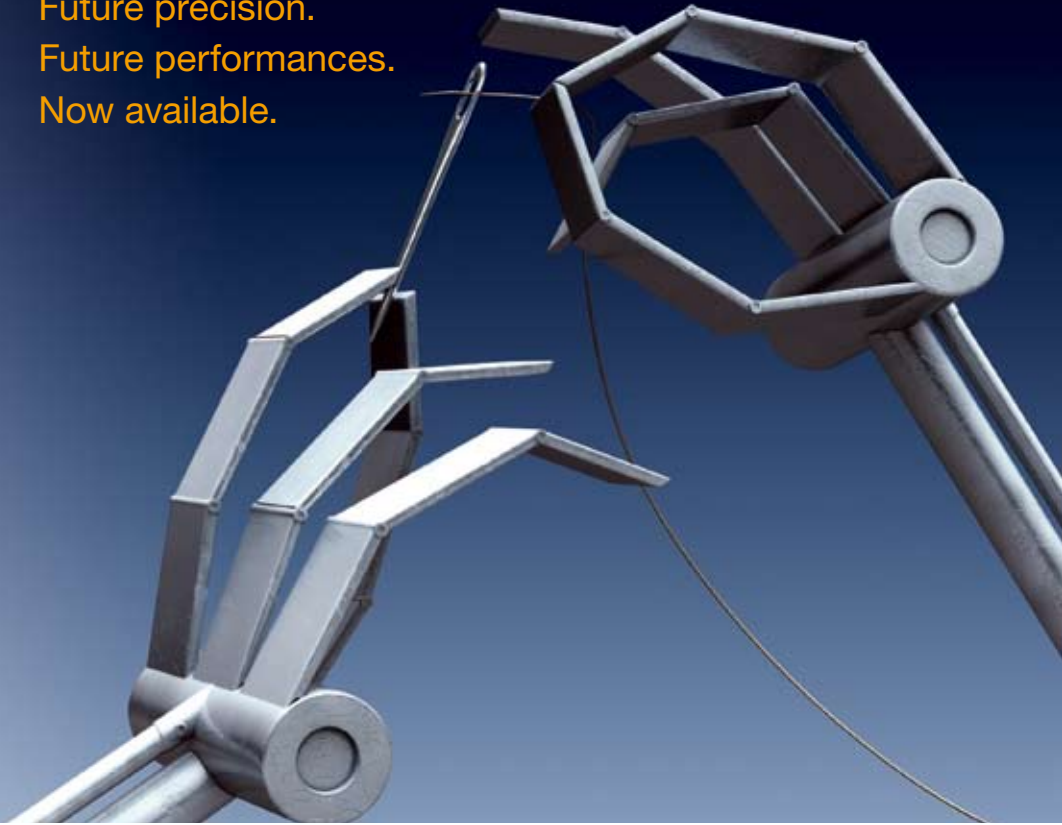

## CAS/CASR/CKSR series Current Transducers Insulated Highly Accurate Measurements from 1.5 to 50 A<sub>RMS</sub>

The Power Electronics market is in constant change and always on the lookout for new technologies and better performance driving our progress. To enable applications with enhanced performance, current measurement must always be made with the best possible performance also allowing to the final application to differentiate itself from all the others.

This is the human nature and allows the progress of technology.

With the LTS/LTSR current transducers using the Closed Loop Hall effect technology coupled with a dedicated ASIC (Application Specific Integrated Circuit) specially designed for these products, we thought we had reached the optimal performance, but this was without taking the eternal human nature into account.

The market required even better accuracy over the temperature ranges maintaining a low price and LEM decided to achieve this goal.

A few months later, LEM delivers the solution with the CAS/CASR/CKSR current transducers series covering nominal current measurements from 1,5 to 50 A<sub>RMS</sub>.

To respond to these new challenges, the Hall effect technology was no longer the solution. Even if used in a Closed Loop configuration and with the use of a dedicated ASIC as done with the LTS family which allowed a substantial performance improvement notably for the accuracy and the size.

Fluxgate technology was selected enabling both possible targets: the improvement in accuracy and the low price.

Without compromising the advantages of the LTS product such as size, dynamic performances, high measuring range, ect.

LEM has already been using multiple Fluxgate technologies in the past and it was just a question to find the one making the best compromise between price, size and performances.

In order for the products to be able to work in the typical industrial applications, the insulation criteria needed to be respected and a particular attention has then been brought to the mechanical design of the product.

Although we were able to reduce the size even when nobody thought it could still be done, the insulation performances allow usage in standard industrial applications without particular mounting with a rated insulation voltage up to 1000 V<sub>RMS</sub> (Simple isolation according to EN 50178 standard with following parameters: OV 3, PD2).

The CAS/CASR/CKSR models have been specially designed to respond to the technology advances in drives and inverters in industrial environment requiring better performances in areas such as:

- Common mode influence
- Thermal drift (offset and gain)
- Accuracy (in the whole temperature range)
- Response time
- Insulation
- Size

# CAS/CASR/CKSR Transducers Technology: Closed Loop Fluxgate technology

Closed Loop current transducers measure current over wide frequency ranges, including DC. They provide contact-free coupling to the current that needs to be measured as well as safe galvanic isolation and high reliability. Their output signal is an accurate, high-resolution image of the primary current with a very short delay.

In higher frequency ranges these transducers function exactly the same way as (passive) current transformers, where a relatively small induced voltage in the secondary winding is capable to drive the secondary current through the secondary winding and, most important, through the burden resistor. A low induced voltage equals low magnetic flux in the magnetic core, which is the cause for the good accuracy (low flux means a small difference between primary and secondary current linkage<sup>1</sup>, too).

For DC and in low-frequency ranges, the induced voltage is too low to be able to drive the secondary current, and the error of simple current transformers will increase with decreasing frequency. In this domain, the magnetic flux density in the core is measured by a sensing element and a voltage is applied to the secondary circuit that in the end keeps the flux density near zero, effectively creating a closed control loop.

The only basic difference between the CAS/CASR/CKSR transducer series and standard Closed Loop transducers of LEM is that the Hall element used for feedback is replaced by a Fluxgate detector. The driving force behind this choice is the need for a “better” feedback, which basically means more voltage per current linkage, a quantity that is called “Open Loop sensitivity”. Given an equal electronic circuit, the zero output of a current transducer (traditionally called “offset” in analogy to operational amplifiers) will be less influenced by changes

in the electronics (e.g. offset variations of the amplifiers used) if the Open Loop sensitivity is higher.

The complexity of a Fluxgate based current transducer is comparable to the one of a transducer based on a Hall effect IC (integrated circuit). Like there, some AC signal processing and synchronous rectifying is applied. In addition, the Fluxgate detector is needed. Fortunately, this Fluxgate is a very simple small solenoid with a tiny soft magnetic strip used as detector core. Because of the complexity of the signal chain, an IC is used to stay at a competitive cost level compared to Hall effect current transducers. A circuit in this IC forms an oscillator together with the Fluxgate, driving it into saturation each half cycle at a frequency of several hundred kilohertz. The effect that is used for the detection of a residual flux in the main transducer core is the fact that in such a configuration a change of the duty cycle of the driving voltage will occur when a magnetic DC flux is present in the fluxgate core.

The signal processing stages in the IC comprise a duty cycle demodulation, frequency response compensation, an integrator and a bridge amplifier that provides the secondary current. This output architecture can provide a higher (doubled) voltage to the secondary circuit when compared to a single output stage with the other side of the circuit connected to a reference potential at typically 2.5 V.

In this configuration, the burden (or measurement) resistor is floating, so in order to obtain an output signal referenced to a fixed voltage, a difference amplifier is used which is also part of the IC.

<sup>1</sup> Current linkage is the technical term for current multiplied by turns count

Fig. 1. Closed Loop Fluxgate Technology used for the CAS/CASR/CKSR current transducers

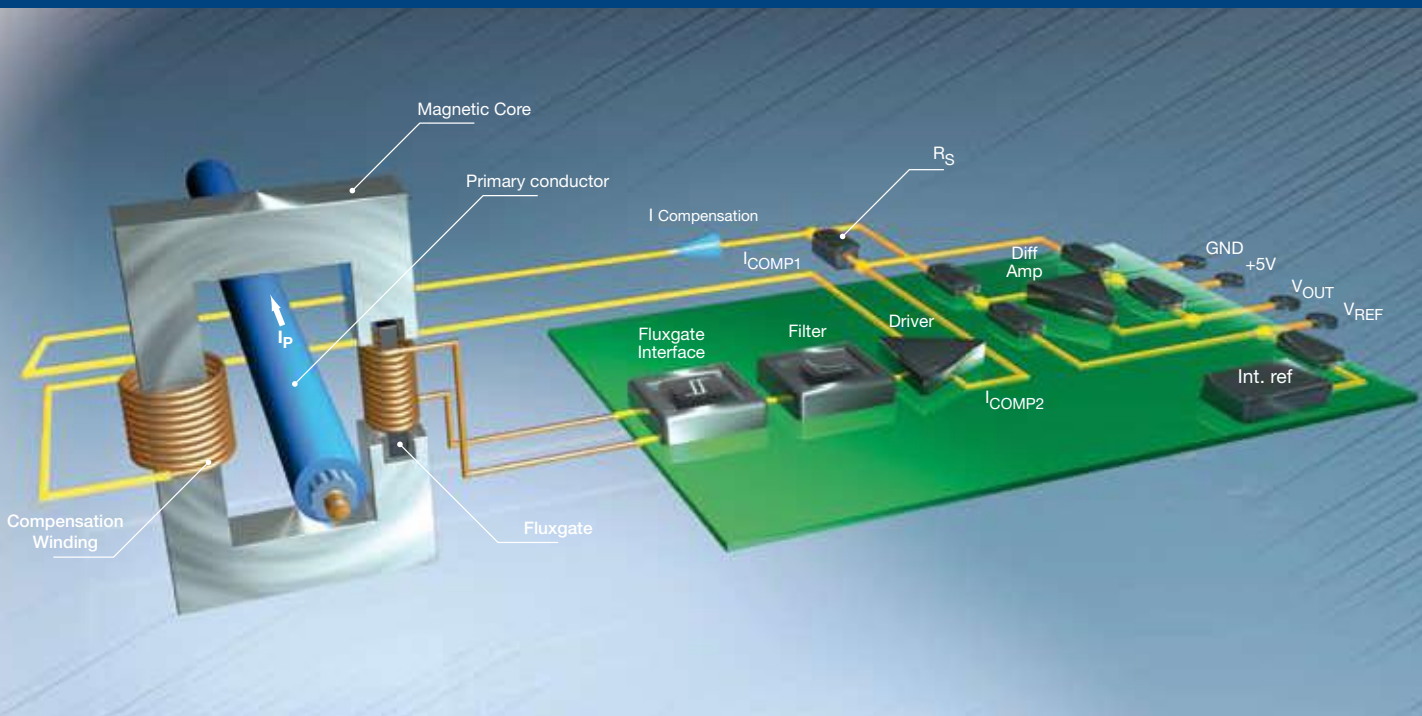

## Mechanical and dimensions

CAS/CASR/CKSR have been designed to provide current measurements from 6 to 50 A<sub>RMS</sub> in a very compact size compared to the existing current transducers based on different technologies allowing to reach similar electrical performances.

Moreover, the same compact design is used to cover the complete current range from 6 to 50 A<sub>RMS</sub> with 4

standard models (6 A, 15 A, 25 A and 50 A models) for each series CAS, CASR and CKSR.

The CAS/CASR/CKSR design is **30 % smaller** in height than LTS transducer (Closed Loop Hall effect chip technology using an ASIC): 16.5 mm height versus 24 mm. 7.5 mm won in height!



Where LTS and LTSR were limited to 25 A<sub>RMS</sub>, with the respective LTS 25-NP and LTSR 25-NP models, as the highest nominal current, the CAS/CASR/CKSR models are offered with a model expected to measure 50 A<sub>RMS</sub> as nominal current. There has been a requirement from the market for years to have a **100% PCB mounted 50 A<sub>RMS</sub> current transducer with single + 5 V power supply** in such a class accuracy.

### Transducers dimensions

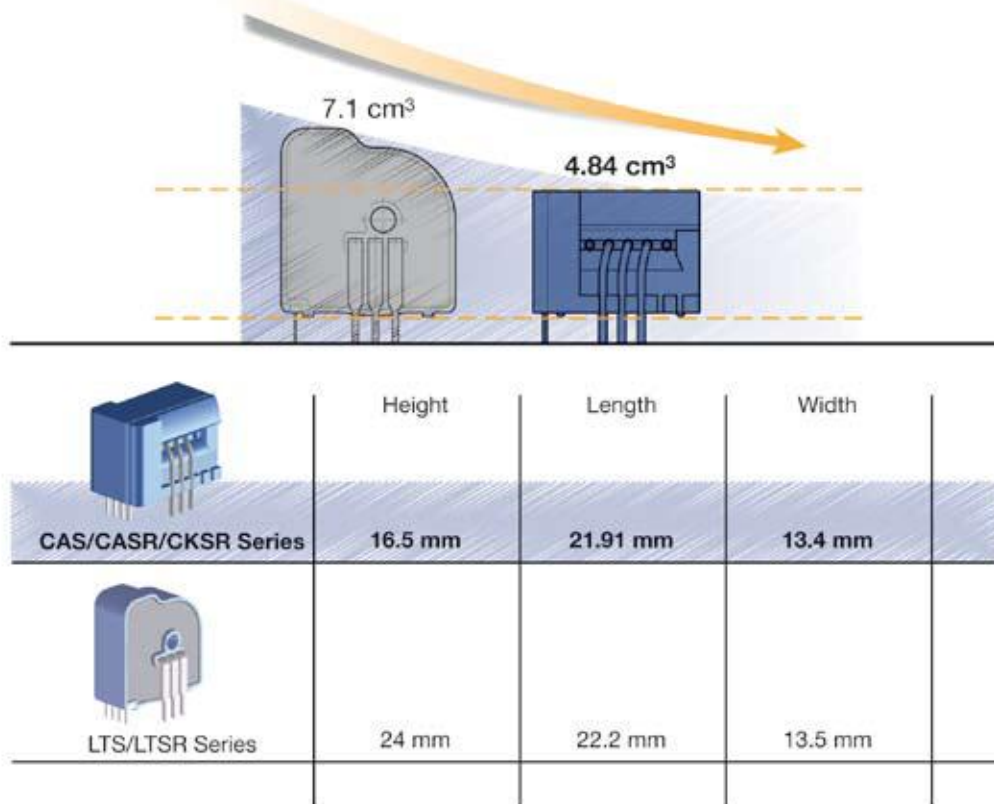

Fig. 2. CAS/CASR/CKSR: 30 % smaller compared to the LTS / LTSR models

## Multifunctional primary circuit

The CAS and CASR construction uses three U-shaped primary terminals integrated into the housing, providing the designer with a great flexibility to perfectly adapt the measuring range of the current transducer to his application.

Fig. 4a shows the different connection possibilities.

Number of primary turns	Primary nominal current rms $I_{PN}$ [A]	Nominal* output voltage $V_{OUT}$ [V]	Primary resistance $R_p$ [mΩ] (typ.) at +25° C	Recommended connections
1	± 25	$2.5 \pm 0.625$	0.24	
2	± 12	$2.5 \pm 0.600$	1.08	
3	± 8	$2.5 \pm 0.600$	2.16	

\* Output voltage CASR 25-NP is used with internal reference.

Fig. 4a. Different nominal current ranges possible according to the primary current circuit configuration (as example: CAS or CASR 25-NP)

### Variant 1

### Variant 2

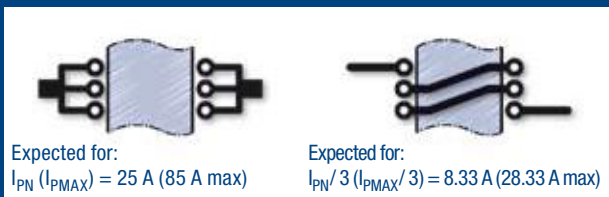

Fig. 4b. The 2 extreme possibilities for connecting the primary current circuit (as example: CAS or CASR 25-NP)

When all three U-shaped terminals are connected in parallel (variant 1 Fig. 4b) the user can measure the maximum nominal primary current.

The variant 2 (Fig.4b) corresponds to a series connection of the primary terminals and leads to a reduction of the nominal measuring range by a factor of 3, but offering a 3 times higher accuracy for low currents.

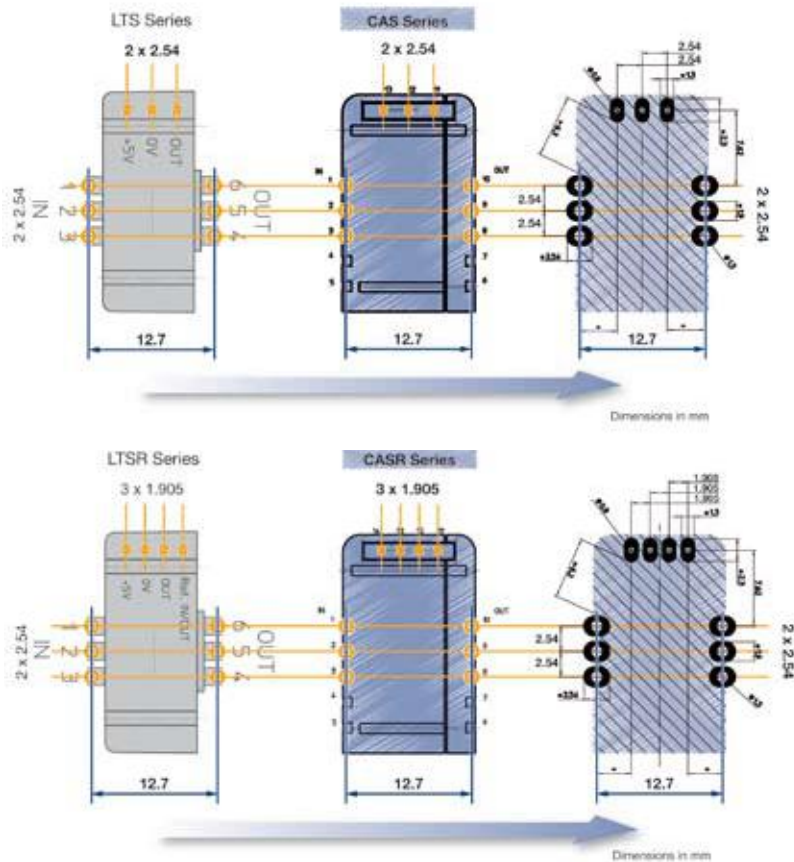

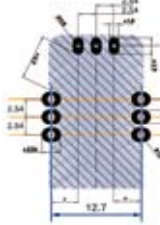

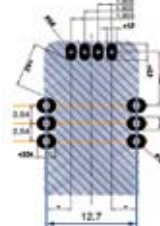

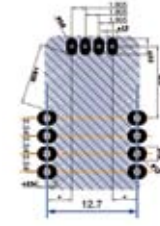

Fig. 3. CAS and CASR transducers can be mounted at the exact place of the LTS and LTSR transducers

The CAS/CASR models are 100% compatible with the LTS and LTSR models in regards to the footprint mounting and also with all the other models that are available on the market with the same footprint as the LTS/LTSR.

## CAS/CASR/CKSR Mechanical differences

Model	3D drawing	Nominal current range	Nb secondary pins	Ref IN/OUT* on a secondary pin	Nb primary pins	Creepage distance	Clearance distance	Footprint drawing	Compatibility with LTS and LTSR footprints
<b>CAS Series</b>									
CAS 6-NP		6	3	NO	3	7.7 mm	7.7 mm		LTS 6-NP
CAS 15-NP		15	3	NO	3	7.7 mm	7.7 mm		LTS 15-NP
CAS 25-NP		25	3	NO	3	7.7 mm	7.7 mm		LTS 25-NP
CAS 50-NP		50	3	NO	3	7.7 mm	7.7 mm		LTS
<b>CASR Series</b>									
CASR 6-NP		6	4	YES	3	7.5 mm	7.5 mm		LTSR 6-NP
CASR 15-NP		15	4	YES	3	7.5 mm	7.5 mm		LTSR 15-NP
CASR 25-NP		25	4	YES	3	7.5 mm	7.5 mm		LTSR 25-NP
CASR 50-NP		50	4	YES	3	7.5 mm	7.5 mm		LTSR
<b>CKSR Series</b>									
CKSR 6-NP		6	4	YES	4	8.2 mm	8.2 mm		/
CKSR 15-NP		15	4	YES	4	8.2 mm	8.2 mm		/
CKSR 25-NP		25	4	YES	4	8.2 mm	8.2 mm		/
CKSR 50-NP		50	4	YES	4	8.2 mm	8.2 mm		/

\* The internal reference voltage is provided on a secondary pin or can be forced by an external reference voltage

The CKSR has one more primary pin (4 primary pins in total) than the CAS and CASR models (3 primary pins in total) making it incompatible with the footprint of these last 8 models. It is possible to measure not less than 1.5 A<sub>RMS</sub> nominal (using a CKSR 6-NP model set up in one of the 4 possible primary pins layout: Layout with 4 turns. Fig. 5) with the performances mentioned in the CKSR 6-NP data sheet.

Using this layout configuration, the current measured by the transducer is still 6 A<sub>RMS</sub> (its designed nominal current) as when connected in series the primary pins have 4 loops (instead of 1 when connected in parallel) through the aperture of the transducer.

Then 4 loops, carrying 1.5 A each, results into a total current of 6 A.t (Amps.turn). Finally, the transducer “sees” a 6 A current.

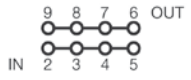
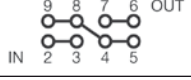
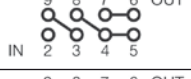
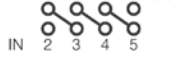
Number of primary turns	Primary nominal current rms I <sub>PN</sub> [A]	Nominal* output voltage V <sub>OUT</sub> [V]	Primary resistance R <sub>p</sub> [mΩ] (typ.) at +25° C	Recommended connections
1	± 6	2.5 ± 0.625	0.18	
2	± 3	2.5 ± 0.625	0.72	
3	± 2	2.5 ± 0.625	1.8	
4	± 1.5	2.5 ± 0.625	2.88	

\* Output voltage CKSR 6-NP is used with internal reference.

Fig. 5. Different nominal current ranges possible according to the primary current circuit configuration – CKSR 6-NP model as example allows nominal current measurement from 1.5 to 6 A<sub>RMS</sub>

Higher insulation provided with the CKSR models thanks to their mechanical design

The CKSR primary pin footprint is different to the CAS and CASR models.

Thanks to this different primary footprint, higher creepage and clearance distances are achieved.

This can be of interest when higher insulation is required for applications under higher working voltages than normal.

Creepage and clearance distances for CKSR models are 8.2 mm (internal distances).

Let's take an example to see the advance this brings.

Conditions of use:

- Creepage distance: 8.2 mm
- Clearance distance: 8.2 mm
- CTI: 600 V (group I)
- Overvoltage category: III
- Pollution Degree: 2

**Basic or Single insulation:**

According to EN 50178 and IEC 61010-1 standards:

With clearance distance of 8.2 mm and PD2 and OV III, the rated insulation voltage is of 1000 V<sub>RMS</sub>.

With a creepage distance of 8.2 mm and PD2 and CTI of 600 V (group I), this leads to a possible rated insulation voltage of 1600 V<sub>RMS</sub>.

In conclusion, the possible rated insulation voltage, in these conditions of use, is 1000 V<sub>RMS</sub> (the lowest value given by the both results from the creepage and clearance distances).

**Reinforced insulation:**

Let's look at the reinforced insulation for the same creepage and clearance distances as previously defined:

When looking at dimensioning reinforced insulation, from the clearance distance point of view, with OV III and according to EN 50178 and IEC 61010-1 standards, the rated insulation voltage is given whatever the pollution degree at 450 V<sub>RMS</sub> (interpolation) or 300 V<sub>RMS</sub> (without interpolation).

From the creepage distance point of view, when dimensioning reinforced insulation, the creepage distance taken into account has to be the real creepage distance divided by 2, that is to say 8.2/2 = 4.1 mm.

With that value, and PD2 and CTI of 600 V (group I), this leads to a possible rated insulation voltage of 800 V<sub>RMS</sub>.

In conclusion, the possible reinforced rated insulation voltage, in these conditions of use, is of 450 V<sub>RMS</sub> (interpolation) or 300 V<sub>RMS</sub> (without interpolation)(the lowest value given by the both results from the creepage and clearance distances).

Using only the EN 50178 standard as a reference for industrial applications, the possible reinforced rated insulation voltage in these conditions of use is of 600 V<sub>RMS</sub>.

With CASR models, not using the special primary pins footprint, the clearance and creepage distances are each of 7.5 mm.

In the same conditions of use as for the CKSR example here before, the result would be the following:

According to EN 50178 and IEC 61010-1 standards:

**Basic or Single insulation** → Rated insulation voltage: 600 V<sub>RMS</sub>.

**Reinforced insulation** → Rated insulation voltage: 404 V<sub>RMS</sub> (interpolation) or 300 V<sub>RMS</sub> (without interpolation).

With CAS models, not using the special primary pins footprint, the clearance and creepage distances are each of 7.7 mm (distances are higher compared to the CASR models as there are only 3 secondary pins versus 4 on the CASR models).

In the same conditions of use as for the CKSR example here before, the result would be the following:

According to EN 50178 and IEC 61010-1 standards:

**Basic or Single insulation** → Rated insulation voltage: 600 V<sub>RMS</sub>.

**Reinforced insulation** → Rated insulation voltage: 417 V<sub>RMS</sub> (interpolation) or 300 V<sub>RMS</sub> (without interpolation).

(Note: all these calculations are done with creepage and clearance distances taken on the transducer itself not mounted on a PCB).

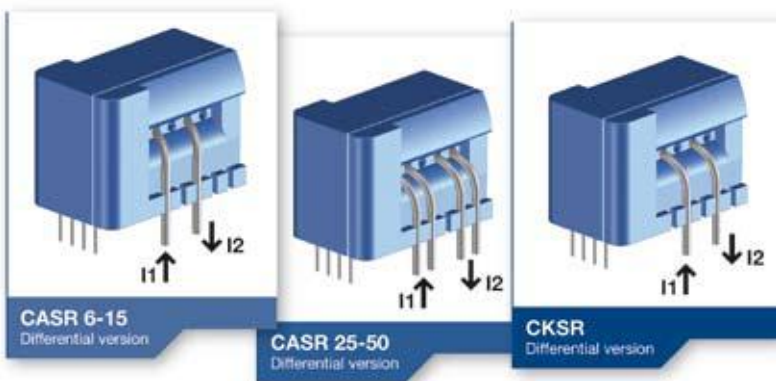

The measurement of differential currents is also possible with special versions of CAS, CASR and CKSR (Fig. 6). These models are possible on request. The current measured is the difference of the currents I1 - I2. For insulation reasons (creepage and clearance distances), these models are designed in order to have enough space between the 2 primary conductors carrying the 2 opposite currents (due to the possible potential difference between the two phases).

Fig. 6: Differential current measurement (I = I1 - I2), many possibilities

## Electrical data

CAS/CASR/CKSR current transducers series have been designed to work with a single +5 V power supply to cover nominal current measurements from 6 to 50 A<sub>RMS</sub>.

This is a common power supply used in the power electronics world to make working the various  $\mu$ processors, or DSPs or ADCs (Analog Digital Converters) ect.

The models provide an analogue voltage output referenced around a reference voltage.

By default, this reference voltage is the internal reference voltage used inside the transducer: 2.5 V + a certain tolerance (please see adequate data sheet according to the model).

Then, at the output, these 2.5 V provided at no primary current can be considered as a virtual "0" V.

The gain is defined in order to get 0.625 V at  $I_{PN}$  whatever the model used (CAS or CASR or CKSR, 6 or 15 or 25 or 50 A<sub>RMS</sub> models).

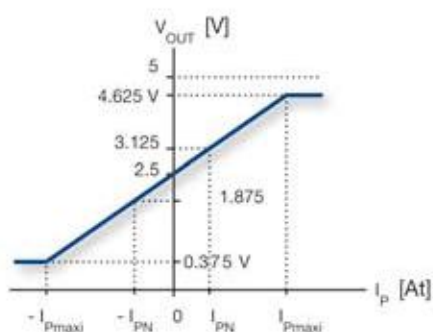

The output voltage range is limited to between 0.375 V for the negative current range and 4.625 V for the positive current range centred around 2.5 V when external reference voltage is not used.

The positive and negative voltage variation spans are each of 2.125 V and fluctuate around the internal voltage reference fixed at 2.5 V.

To define the measuring range, just divide the possible max voltage variation span (positive or negative) by the gain defined by the concerned model.

In general, the measuring range provided for each model is more than 3 times the nominal current.

For the 50 A models (CAS 50-NP, CASR 50-NP and CKSR 50-NP), the current measuring range is limited to +/- 150 A (nevertheless 3 times the nominal current) (due to some current limitations inside the transducer) meaning only 1.875 V as positive and negative variation spans, resulting in a minimum output voltage of 0.625 V for -150 A and in a maximum output voltage of 4.375 V for +150 A.

However, for these 50 A models, the limits for output voltage rails remain +0.375 V and +4.625 V.

With the CASR and CKSR models, the internal voltage reference is provided on a separate secondary additional pin called  $V_{REF}$  what is not the case with the CAS models.

This pin is a direct access to the voltage reference used inside set around 2.5 V.

The Ref pin has two basic functional modes:

The first mode is called "Ref out mode". In this mode, for a primary current of 0 A, the output voltage is equal to the

voltage at the Ref pin + an offset depending to the model used (between the voltage output and the Ref pin).

The voltage provided at the Ref pin (Typically 2.5 V) stays stable although the primary current changes.

The second mode is called "Ref in mode". In this mode, you can apply an external voltage to the Ref pin to overdrive the internal voltage reference. The minimum external voltage is 0 V and maximum 4 V. However, this mode defines different measuring ranges according to the level of the external voltage reference used (0 to 4 V) and according to the model used (6, 15, 25 or 50 A model).

For more information on these 2 modes, please refer to the chapter "Application advice".

With zero primary current, the consumption is max 20 mA. With more than zero primary current, the transducer consumes 20 mA max + (the primary current divided by the number of turns used by the transducer:  $I_P / N_s$ ).

## Accuracy

Using a Closed Loop Fluxgate technology allows reaching accuracy that was impossible with traditional Closed Loop Hall effect based technology (even with a dedicated ASIC).

Some applications required higher accuracy especially for lower offset and gain drifts in temperature ranges.

CAS/CASR/CKSR models achieve an accuracy of 0.8 % of  $I_{PN}$  at +25°C regardless of the model and the following accuracy at +85°C:

CAS: 2.5 to 3 % of  $I_{PN}$

CASR: 1.2 to 1.8 % of  $I_{PN}$

CKSR: 1.2 to 1.8 % of  $I_{PN}$

As you can see, the accuracy of the CAS is less good as the CASR and CKSR models.

This is explained as follows: The CAS models do not provide the internal voltage reference outside and then the voltage output integrating the voltage reference inaccuracy.

What is not the case with the CASR and CKSR models providing their internal voltage reference outside or being able to feed their internal voltage reference with an external voltage reference. When using both these last models (CASR and CKSR), the output ( $V_{OUT}$ ) is usually measured referenced to the voltage available on the voltage reference pin (which one is used as reference for the whole electronic of the application).

The voltage reference value available on this pin being well known and under control (used and usually controlled by the microcontroller or DSP), the microcontroller can easily remove the initial offset at +25°C at no primary current.

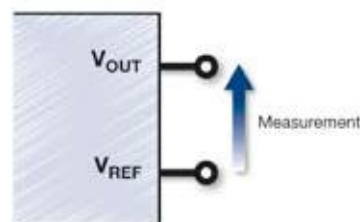









It is also possible to cancel the offset drift of the reference voltage when working over the defined temperature range by using the same method.

The use of the **Closed Loop Fluxgate technology** allowed achieving significantly better performances for the following parameters:

- Initial offset at +25°C
- Offset drift
- Gain drift

as expressed per the following charts (Fig. 7: Comparison between CAS and LTS ; CASR and LTSR models).

		CAS 6-NP		LTS 6-NP		CAS 15-NP		LTS 15-NP		CAS 25-NP		LTS 25-NP	
													
Nominal current, $I_{PN}$	A	6		15		25							
Measuring range	A	20	19.2	51	48	85	80						
Response time	us	< 0.3	0.4	< 0.3	0.4	< 0.3	0.4						
Bandwidth ( $\pm 1$ dB)	kHz	200	200	200	200	200	200						
Output voltage noise, 100 Hz..10 kHz (typ.)	mVpp	2.4	10	1.0	4.2	0.6	2.5						
Output		Voltage		Voltage		Voltage							
Sensitivity	mV/A	104.2		41.7		25.0							
Sensitivity error (max)	% of $I_{PN}$	0.7	0.6	0.7	0.6	0.7	0.6						
Offset drift (25°C .. 85°C) (max)	% of $I_{PN}$	1.92	4.8	1.68	2.9	1.44	2.4						
Sensitivity drift (25°C .. 85°C) (max)	% of $I_{PN}$	0.24	0.3	0.24	0.3	0.24	0.3						
Linearity (max)	% of $I_{PN}$	0.1	0.1	0.1	0.1	0.1	0.1						
<b>Accuracy at +25 °C (max)</b>	<b>% of <math>I_{PN}</math></b>	<b>0.80</b>	<b>0.70</b>	<b>0.80</b>	<b>0.70</b>	<b>0.80</b>	<b>0.70</b>						
<b>Accuracy at +85 °C (max)</b>	<b>% of <math>I_{PN}</math></b>	<b>3.0</b>	<b>5.80</b>	<b>2.7</b>	<b>3.58</b>	<b>2.5</b>	<b>3.40</b>						
Offset (max)	mV	10.4	25	7.1	25	6.3	25						
Operating temperature range	°C	-40 .. 85		-40 .. 85		-40 .. 85							







		CASR 6-NP		LTSR 6-NP		CASR 15-NP		LTSR 15-NP		CASR 25-NP		LTSR 25-NP	
													
Nominal current, $I_{PN}$	A	6		15		25							
Measuring range	A	20	19.2	51	48	85	80						
Response time	us	< 0.3	0.4	< 0.3	0.4	< 0.3	0.4						
Bandwidth ( $\pm 1$ dB)	kHz	200	200	200	200	200	200						
Output voltage noise, 100 Hz..10 kHz (typ.)	mVpp	1.7	10	0.7	4.2	0.4	2.5						
Output		Voltage		Voltage		Voltage							
Sensitivity	mV/A	104.2		41.7		25.0							
Sensitivity error (max)	% of $I_{PN}$	0.7	0.6	0.7	0.6	0.7	0.6						
Offset drift (25°C .. 85°C) (max)	% of $I_{PN}$	0.72	3.6	0.48	1.5	0.24	0.9						
Sensitivity drift (25°C .. 85°C) (max)	% of $I_{PN}$	0.24	0.3	0.24	0.3	0.24	0.3						
Linearity (max)	% of $I_{PN}$	0.1	0.1	0.1	0.1	0.1	0.1						
<b>Accuracy at +25 °C (max)</b>	<b>% of <math>I_{PN}</math></b>	<b>0.8</b>	<b>0.70</b>	<b>0.8</b>	<b>0.70</b>	<b>0.8</b>	<b>0.70</b>						
<b>Accuracy at +85 °C (max)</b>	<b>% of <math>I_{PN}</math></b>	<b>1.8</b>	<b>4.60</b>	<b>1.5</b>	<b>2.54</b>	<b>1.3</b>	<b>1.90</b>						
Offset max	mV	5.3	25	2.2	25	1.4	25						
Operating temperature range	°C	-40 .. 85		-40 .. 85		-40 .. 85							

Fig. 7. Comparison between CAS and LTS ; CASR and LTSR models – Electrical performances

## Dynamic performances

CAS/CASR/CKSR transducers max response times (Response time defined at 90 % of  $I_{PN}$ ) against a current step at  $I_{PN}$  will have a delay of Max  $0.3 \mu s$  (Fig. 8).

As a result of the fast response time, a large bandwidth has been verified at 300 kHz @ +/-3 dB (Fig. 9).

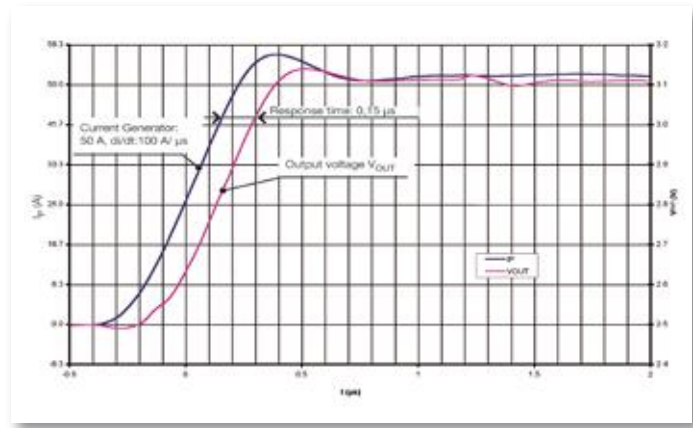

Fig. 8. CASR 50-NP Response time to a current step of 50 A

Fig. 10a. Typical common mode behaviour (1200 V of voltage variation applied with  $dv/dt = 20 \text{ kV}/\mu s$ )

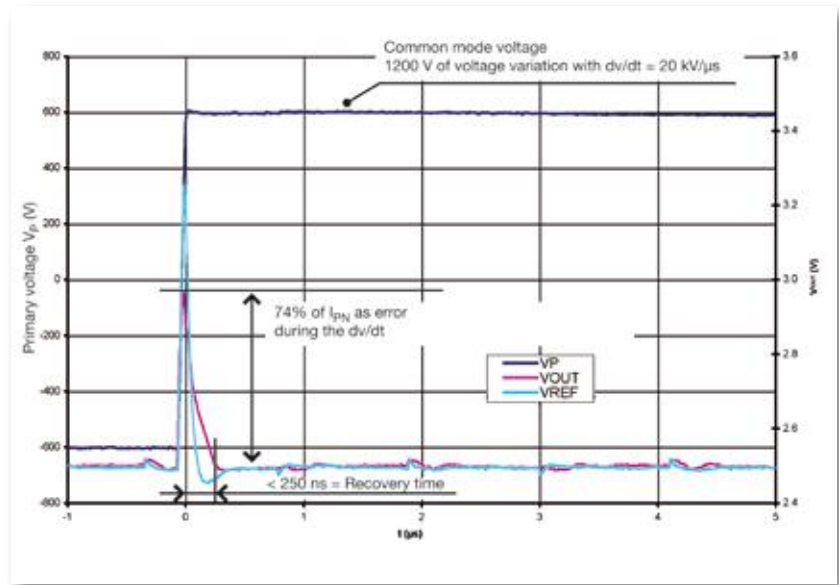
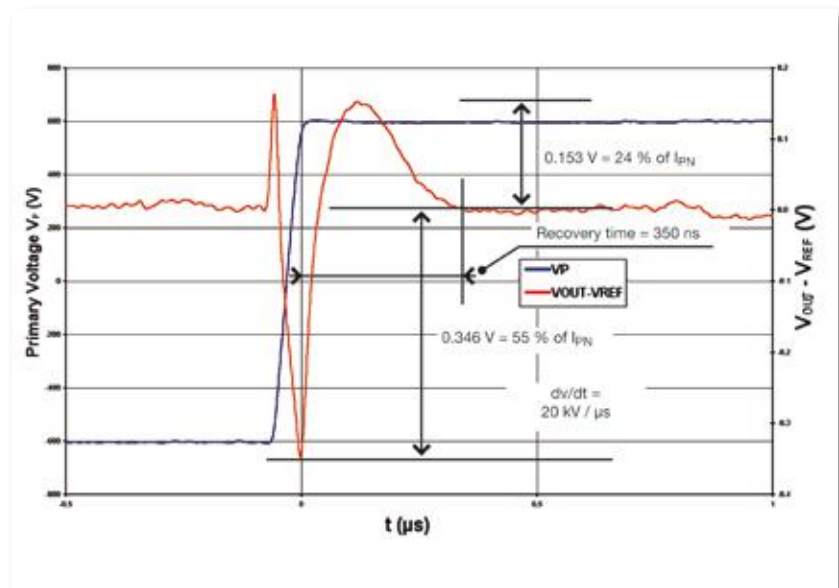

Fig. 10b. CASR 50-NP ; Typical common mode behaviour ;  $V_{OUT} - V_{REF}$  ; (1200 V of voltage variation applied with  $dv/dt = 20 \text{ kV}/\mu s$ )



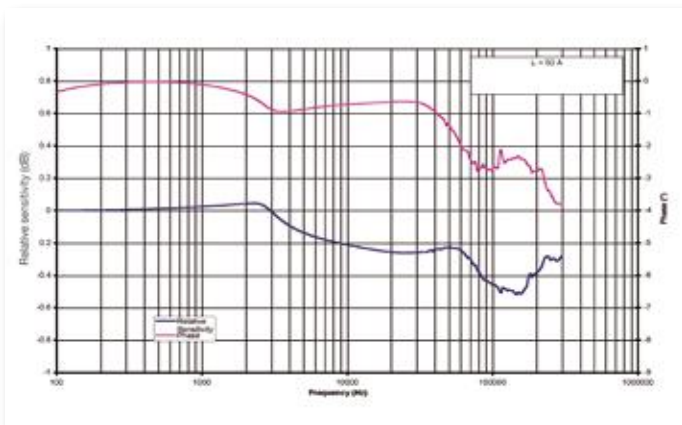

Fig. 9. CASR 50-NP - Frequency response

## Common mode behaviour

Common mode noises ( $dv/dt$ ) are often encountered in applications using fast switching components like IGBTs. It is not surprising to encounter switching frequencies up to and even higher than 20 kHz for highly efficient inverters.

The result of a  $dv/dt$  between the primary conductor and the electronic circuit of a current transducer is a capacitive current perturbing the various electronic components that are sensitive to that.

Any electrical component with a galvanic isolation between the primary and the secondary circuit has a capacitive coupling between the isolated potentials.

This capacitive current results in an additional error on the transducer output during a short time.

The error caused by these  $dv/dt$  has to be as low as possible in order to avoid any unwanted activation of a possible protection circuit, which could lead to a shut down of the application.

This additional noise caused by the  $dv/dt$  can be filtered, but the best way is to have it at the lowest possible value and during the shortest time avoiding then any additional filter to be installed.

For example, a voltage change of  $10 \text{ kV}/\mu\text{s}$  in combination with a  $10 \text{ pF}$  coupling capacity generates a parasitic output current of  $100 \text{ mA}$ . For the CAS 25-NP for example, this would represent seven times the nominal current.

Fig. 10a shows the behaviour at a voltage change of  $20 \text{ kV}/\mu\text{s}$  and an applied voltage of  $+600 \text{ V}$  (total voltage variation of  $1200 \text{ V}$  from  $-600 \text{ V}$  to  $+600 \text{ V}$ ) with a CASR 50-NP.

Due to CAS-CASR-CKSR low parasitic capacitance, the effect of dynamic common mode is reduced. We can notice an interference of about 74 % of  $I_{PN}$  during the  $dv/dt$  when measurement  $V_{OUT}$  is referenced to  $0 \text{ V}$ . Note the **very short duration of the disturbance of less than 250 ns**, which can be easily filtered. When  $V_{OUT}$  is referenced to  $V_{REF}$  to do the output measurement, then the disturbance during  $dv/dt$  seen on the output is equal to the difference between the disturbance on  $V_{OUT}$  and the disturbance on  $V_{REF}$  (Fig. 10b). In these conditions, we can notice on the output signal ( $V_{OUT} - V_{REF}$ ) an interference of about 55 % of  $I_{PN}$  during the  $dv/dt$  and 24 % of  $I_{PN}$  after the  $dv/dt$ , the signal coming back to its normal state only 350 ns after the end of the  $dv/dt$ .

## Standards

The CAS/CASR/CKSR models have been designed and tested according to latest recognized worldwide standards for industrial applications:

The **EN 50178** standard dedicated to “Electronic Equipment for use in power installations” in industrial applications is our standard of reference for electrical, environmental and mechanical parameters.

It guarantees the overall performances of our products in industrial environments.

CAS/CASR/CKSR products are **CE marked** as a guarantee of the products compliance to the **European EMC directive 89/336/EEC** and **low voltage directive**. They also comply with the derived local EMC regulations (EMC: Electro-Magnetic Compatibility).



## Insulation and safety

The **EN 50178** and **IEC 61010-1** standards (“Safety requirements for electrical equipment for measurement, control, and laboratory use”) are used as references to design the creepage and clearance distances versus the needed insulation levels (rated insulation voltage) and the conditions of use (as previously seen page 7).

The rated insulation voltage level for transducers in “industrial” applications, is defined according to several criteria listed under the both standards EN 50178 and IEC 61010-1. Some criteria are dependent on the transducer itself when the others are linked to the application.

The products comply with **UL 508C** for **UR marking**.



## Reliability and Quality

Of course, reliability and lifetime are guaranteed by the quality in design and process. Accelerated tests have been performed to estimate failure rate (temperature cycle and/or humidity test and complete characterization of the product according to standards).

Beside, the CAS/CASR/CKSR models have been designed to **pass the  $+85^\circ\text{C} + 85\%$  relative humidity test during 1000 hours** (transducers power supplied during the test).

The CAS/CASR/CKSR models are manufactured in one of the LEM production center that is ISO/TS 16949, ISO 14001, ISO 9001:2000 and IRIS certified and where quality tools such as DPT FMEA, Control Plan, Cpk, R&R, QOS-8D, IPQ, ect are used in addition to the Six Sigma methodology.

## Filtering Vout

The output Vout has a very low output impedance of typically 2 Ω; it can drive 100 pF directly and shows 50% overshoot with approximately 1 nF capacitance. Adding Rf allows much larger capacitive loads. Note that with Rf of only 20 Ω, the load capacitor should be either smaller than 1 nF or larger than 33 nF to avoid overshoot; with Rf of 50 Ω this transient area is avoided.

Empirical evaluation may be necessary to obtain optimum results.

Example: Filtering the typical 450 kHz frequency of the detector:

To have an attenuation of 20 dB at 450 kHz, the cutting frequency of the 1st order filter is chosen at Fc=45 kHz.

To avoid transient area, the resistance Rf is chosen at 50 Ω.

The filter capacitor is then as per Fig. 11.

## Load output resistance: R<sub>L</sub>

The minimum load resistance of Vout is 1 kOhm.

## Reference Voltage

If the Ref pin of the transducer is not used it must be left unconnected.

No special filtering is needed for Ref pin.

The Ref pin has two modes Ref in and Ref out:

- In the **Ref out mode**, the 2.5 V internal precision reference is used by the transducer as the reference point for bipolar measurements; this internal reference is connected to the Ref pin of the transducer through a 680 Ω resistor. It tolerates sink or source currents up to ±5 mA, but the 680 Ω resistor prevents this current to exceed these limits.

When the Ref pin is connected to a load, due to the leakage current and internal resistance (680 Ω), V<sub>REF</sub> OUT (internal reference) can change and reduce the measuring range. To guarantee the measuring range:

- The leakage current from the Ref pin (source) must be lower than 350 μA when the load is connected to a voltage > 2.5 V.
- The leakage current from the Ref pin (sink) must be lower than 4.4 μA when the load is connected to a voltage < 2.5 V.
- In the **Ref in mode**, an external reference voltage is connected to the Ref pin; this voltage is specified in the range 0 to 4 V and is directly used by the transducer as the reference point for measurements.

The external reference voltage V<sub>REF</sub> must be able:

- Either to source a typical current of  $\frac{V_{ref} - 2.5}{680}$ , the maximum value will be 2.2 mA typ. when V<sub>REF</sub> = 4 V.
- Or to sink a typical current of  $\frac{2.5 - V_{ref}}{680}$ , the maximum value will be 3.68 mA typ. when V<sub>REF</sub> = 0 V.

By using an external reference, it is easier to connect the transducer to devices such as an ADC.

In most applications, the output of the transducer is connected to an ADC whose output is processed by a DSP or a microcontroller.

The internal reference of these DSPs or ADCs can go down to 1.8 V.

In this application, if you have an internal reference in the DSP with external access, you can supply the transducer's reference in with it.

Fig. 11.

$$C_f = \frac{1}{2 * \pi * R_f * F_c} \quad C_f = \frac{1}{2 * \pi * 50 * 45E3}$$

$$C_f \geq 70.7 \text{ nF}$$

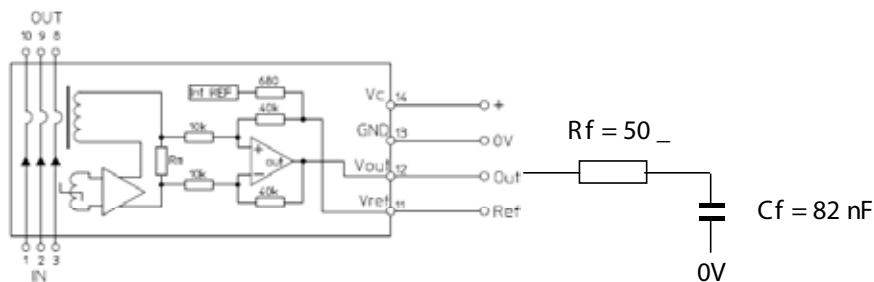

The following graphs show how the measuring range of each transducer version depends on the external reference voltage value  $V_{REF}$ :

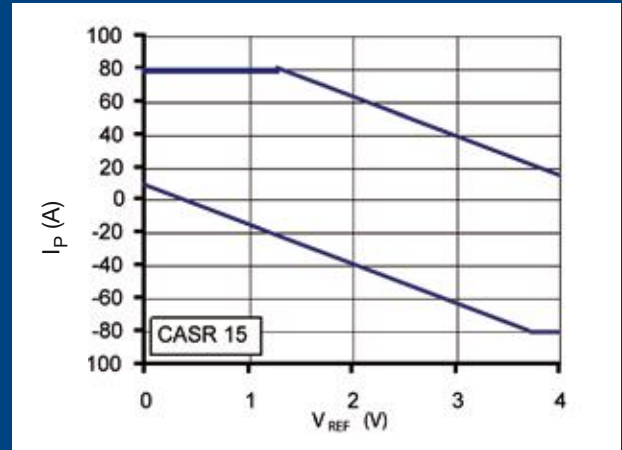
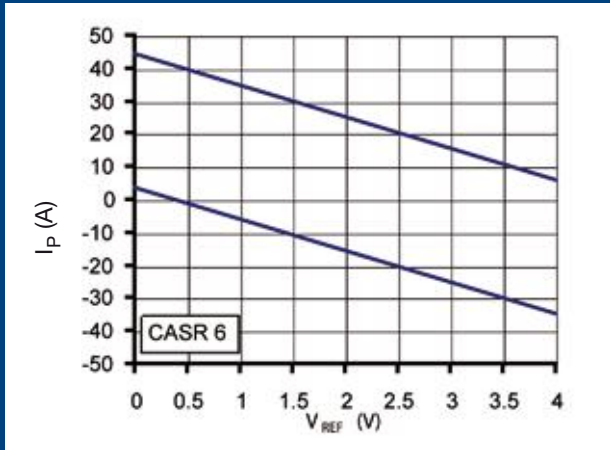

Upper limit: $I_p = -9.6 \times V_{REF} + 44.4$ ( $V_{REF} = 0 \dots 4$ V)	Upper limit: $I_p = -24 \times V_{REF} + 111$ ( $V_{REF} = 1.29 \dots 4$ V)
Lower limit: $I_p = -9.6 \times V_{REF} + 3.6$ ( $V_{REF} = 0 \dots 4$ V)	Upper limit: $I_p = 80$ ( $V_{REF} = 0 \dots 1.29$ V)
	Lower limit: $I_p = -24 \times V_{REF} + 9$ ( $V_{REF} = 0 \dots 3.7$ V)
	Lower limit: $I_p = -80$ ( $V_{REF} = 3.7 \dots 4$ V)

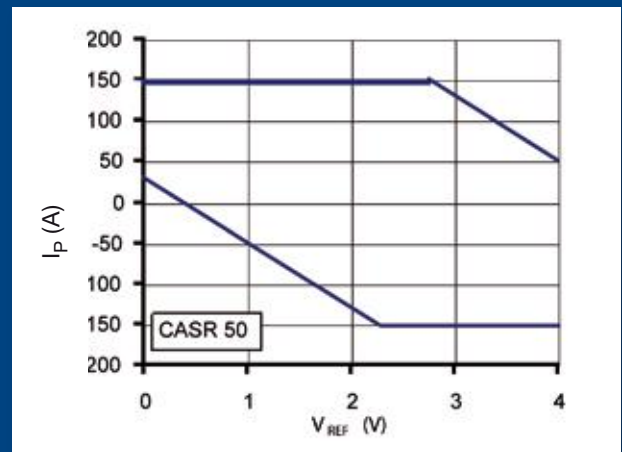
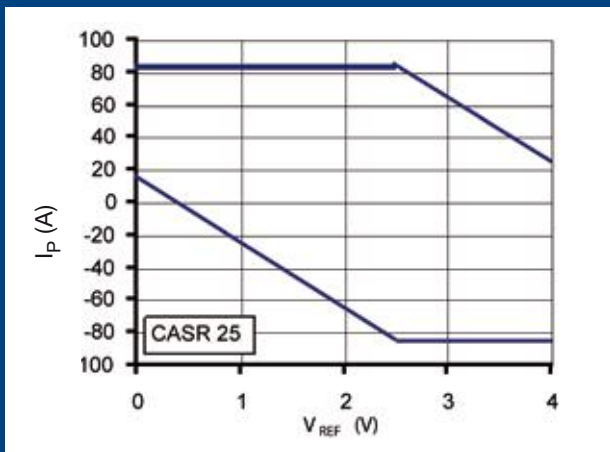

Upper limit: $I_p = -40 \times V_{REF} + 185$ ( $V_{REF} = 2.5 \dots 4$ V)	Upper limit: $I_p = -80 \times V_{REF} + 370$ ( $V_{REF} = 2.75 \dots 4$ V)
Upper limit: $I_p = 85$ ( $V_{REF} = 0 \dots 2.5$ V)	Upper limit: $I_p = 150$ ( $V_{REF} = 0 \dots 2.75$ V)
Lower limit: $I_p = -40 \times V_{REF} + 15$ ( $V_{REF} = 0 \dots 2.5$ V)	Lower limit: $I_p = -80 \times V_{REF} + 30$ ( $V_{REF} = 0 \dots 2.25$ V)
Lower limit: $I_p = -85$ ( $V_{REF} = 2.5 \dots 4$ V)	Lower limit: $I_p = -150$ ( $V_{REF} = 2.25 \dots 4$ V)

#### Example with $V_{REF} = 1.65$ V:

- The 6 A version has a measuring range from -12.24 A to +28.5 A
- The 15 A version has a measuring range from -30.6 A to +71.4 A
- The 25 A version has a measuring range from -51 A to +85 A
- The 50 A version has a measuring range from -102 A to +150 A

#### Example with $V_{REF} = 0$ V:

- The 6 A version has a measuring range from +3.6 A to +44.4 A
- The 15 A version has a measuring range from +9 A to +80 A
- The 25 A version has a measuring range from +15 A to +85 A
- The 50 A version has a measuring range from +30 A to +150 A

## Primary conductor resistance

At 25 °C, one primary conductor has a resistance of 0.72 mΩ typ.

At 85 °C, one primary conductor has a resistance of 0.88 mΩ typ.

Number of primary conductor	Connection	Temperature	Resistance typ.
3	Parallel	25° C	0.24 mΩ
4	Parallel	25° C	0.18 mΩ
3	Parallel	85° C	0.29 mΩ
4	Parallel	85° C	0.22 mΩ
3	Series	25° C	2.16 mΩ
4	Series	25° C	2.88 mΩ
3	Series	85° C	2.64 mΩ
4	Series	85° C	3.52 mΩ



## Typical applications & conclusion

The CAS/CASR/CKSR current transducers have been designed mainly for industrial applications requiring:

- **Good accuracy** especially in temperature (low initial offset, low thermal drifts for gain and offset)
- **Reduced size:** CAS/CASR/CKSR are the smallest on the market in their category (up to nominal current of 50 A<sub>RMS</sub>)
- **High immunity against high voltage variations**
- **High flexibility** for specific customer applications (wide choice of current ranges: 6, 15, 25 and 50 A<sub>RMS</sub>, each model is **multi range**, unique packaging)
- **High Creepage and Clearance distances** with the CKSR models for **higher insulation**
- Measures the same given performance current as small as **1.5 A<sub>RMS</sub>** with the CKSR 6-NP model
- Resistant in rough environmental conditions of use such as **high humidity combined with high temperature**

These advantages are suited for high performance drives, inverters for new energy integrating a good control of the DC current injection in the grid, servo drives for wafers production or highly accurate robots and all kinds of low drift applications. After all, they have been created to achieve great performance not only today - but as far into the future as you can imagine.



## Absolute maximum ratings

Parameter	Symbol	Unit	Value
Supply voltage	$V_C$	V	7
Primary conductor temperature		°C	110
ESD rating, Human Body Model (HBM)		kV	4

Stresses above these ratings may cause permanent damage. Exposure to absolute maximum ratings for extended periods may degrade reliability.

## Isolation characteristics

Parameter		Unit	CAS Value	CASR Value	CKSR Value	Comment
RMS voltage for AC isolation test 50/60Hz/1 min	$V_d$	kV	4.2	4.1	4.3	
Impulse withstand voltage 1.2/50 $\mu$ s	$\hat{V}_w$	kV	7.6	7.5	8	
Partial discharge extinction voltage @ 10 pC (rms)	$V_e$	V	1000	1000	1000	
Clearance distance (pri. - sec.)	dCl	mm	7.7	7.5	8.2	Shortest distance through air
Creepage distance (pri. - sec.)	dCp	mm	7.7	7.5	8.2	Shortest path along device body (CAS-CASR) Shortest internal path along device body (CKSR)
Creepage distance (pri. - sec.)	-	mm	6.3	6.2	-	When mounted on PCB with recommended layout (CAS-CASR)
Case material	-	-	V0 according to UL 94	V0 according to UL 94	V0 according to UL 94	
Comparative tracking index	CTI	V	600	600	600	
Application example	-	-	300 V CAT III PD2	300 V CAT III PD2	300 V CAT III PD2	Reinforced isolation, non uniform field according to EN 50178, EN 61010, IEC 60364-4-43
Application example	-	-	600 V CAT III PD2	600 V CAT III PD2	1000 V CAT III PD2	Simple isolation, non uniform field according to EN 50178, EN 61010, IEC 60364-4-43

## Environmental and mechanical characteristics

Parameter	Symbol	Unit	Min	Typ	Max	Comment
Ambient operating temperature	$T_A$	°C	-40		85	
Ambient storage temperature	$T_S$	°C	-50		105	
Mass	m	g		9		
Standards	EN 50178, IEC 60950-1, IEC 61010-1, IEC 61326-1, UL 508C					



## Electrical data CAS/CASR/CKSR 6-NP

At  $T_A = 25^\circ\text{C}$ ,  $V_C = +5\text{ V}$ ,  $N_p = 1$  turn,  $R_L = 10\text{ k}\Omega$ , (internal reference for CASR & CKSR models) unless otherwise noted.

Parameter	Symbol	Unit	Min	Typ	Max	Comment
Primary nominal current rms	$I_{PN}$	A		6		
Primary current, measuring range	$I_{PM}$	A	-20		20	
Number of primary turns	$N_p$	-		1,2,3		for CAS / CASR
		-		1,2,3,4		for CKSR
Supply voltage	$V_C$	V	4.75	5	5.25	
Current consumption	$I_C$	mA		$15 + \frac{I_p(\text{mA})}{N_s}$	$20 + \frac{I_p(\text{mA})}{N_s}$	$N_s = 1731$ turns
Reference voltage @ $I_p = 0\text{ A}$	$V_{REF}$	V	2.495	2.5	2.505	Internal reference for CASR / CKSR
External reference voltage	$V_{REF}$	V	0		4	for CASR / CKSR
Output voltage	$V_{OUT}$	V	0.375		4.625	
Output voltage @ $I_p = 0\text{ A}$	$V_{OUT}$	V		2.5		for CAS
				$V_{REF}$		for CASR / CKSR
Electrical offset voltage	$V_{OE}$	mV	-10.4		10.4	100% tested $V_{OUT} - 2.5\text{ V}$ for CAS $V_{OUT} - V_{REF}$ for CASR / CKSR
			-5.3		5.3	
Electrical offset current referred to primary	$I_{OE}$	A	-0.1		0.1	100% tested for CAS
		mA	-51		51	100% tested for CASR / CKSR
Temperature coefficient of $V_{REF}$	$TCV_{REF}$	ppm/K		$\pm 5$	$\pm 50$	Internal reference for CASR / CKSR
Temperature coefficient of $V_{OUT}$ @ $I_p = 0\text{ A}$	$TCV_{OUT}$	ppm/K		$\pm 10$	$\pm 80$	ppm/K of 2.5 V - 40°C .. 85°C for CAS
				$\pm 6$	$\pm 30$	ppm/K of 2.5 V - 40°C .. 85°C for CASR / CKSR
Theoretical sensitivity	Gth	mV/A		104.2		625 mV / $I_{PN}$
Sensitivity error	$\epsilon_G$	%	-0.7		0.7	100% tested
Temperature coefficient of G	TCG	ppm/K			$\pm 40$	- 40°C .. 85°C
Linearity error	$\epsilon_L$	% of $I_{PN}$	-0.1		0.1	
Magnetic offset current (10 x $I_{PN}$ ) referred to primary	$I_{OM}$	A	-0.1		0.1	
Output current noise (spectral density) rms 100 Hz .. 100 kHz referred to primary	$i_{no}$	$\mu\text{A}/\text{Hz}^{1/2}$		36		$R_L = 1\text{ k}\Omega$ for CAS
				20		$R_L = 1\text{ k}\Omega$ for CASR / CKSR
Peak-peak output ripple at oscillator frequency $f = 450\text{ kHz}$ (typ.)	-	mV		40	160	$R_L = 1\text{ k}\Omega$
Reaction time @ 10 % of $I_{PN}$	$t_{ra}$	$\mu\text{s}$			0.3	$R_L = 1\text{ k}\Omega$ $di/dt = 18\text{ A}/\mu\text{s}$
Response time @ 90 % of $I_{PN}$	$t_r$	$\mu\text{s}$			0.3	$R_L = 1\text{ k}\Omega$ $di/dt = 18\text{ A}/\mu\text{s}$
Frequency bandwidth ( $\pm 1\text{ dB}$ )	BW	kHz	200			$R_L = 1\text{ k}\Omega$
Frequency bandwidth ( $\pm 3\text{ dB}$ )	BW	kHz	300			$R_L = 1\text{ k}\Omega$
Overall accuracy	$X_G$	% of $I_{PN}$			2.5	for CAS
					1.7	for CASR / CKSR
Overall accuracy @ $T_A = 85^\circ\text{C}$	$X_G$	% of $I_{PN}$			4.6	for CAS
					2.6	for CASR / CKSR
Accuracy	X	% of $I_{PN}$			0.8	
Accuracy @ $T_A = 85^\circ\text{C}$	X	% of $I_{PN}$			3.0	for CAS
					1.8	for CASR / CKSR

## Electrical data CAS/CASR/CKSR 15-NP

At  $T_A = 25^\circ\text{C}$ ,  $V_C = +5\text{ V}$ ,  $N_P = 1\text{ turn}$ ,  $R_L = 10\text{ k}\Omega$ , (internal reference for CASR & CKSR models) unless otherwise noted.

Parameter	Symbol	Unit	Min	Typ	Max	Comment
Primary nominal current rms	$I_{PN}$	A		15		
Primary current, measuring range	$I_{PM}$	A	-51		51	
Number of primary turns	$N_P$	-		1,2,3		for CAS / CASR
		-		1,2,3,4		for CKSR
Supply voltage	$V_C$	V	4.75	5	5.25	
Current consumption	$I_C$	mA		$15 + \frac{I_p(\text{mA})}{N_s}$	$20 + \frac{I_p(\text{mA})}{N_s}$	$N_s = 1731\text{ turns}$
Reference voltage @ $I_p = 0\text{ A}$	$V_{REF}$	V	2.495	2.5	2.505	Internal reference for CASR / CKSR
External reference voltage	$V_{REF}$	V	0		4	for CASR / CKSR
Output voltage	$V_{OUT}$	V	0.375		4.625	
Output voltage @ $I_p = 0\text{ A}$	$V_{OUT}$	V		2.5		for CAS
		V		$V_{REF}$		for CASR/CKSR
Electrical offset voltage	$V_{OE}$	mV	-7.1		7.1	100% tested $V_{OUT} - 2.5\text{ V}$ for CAS
		mV	-2.21		2.21	$V_{OUT} - V_{REF}$ for CASR / CKSR
Electrical offset current referred to primary	$I_{OE}$	A	-0.17		0.17	100% tested for CAS
		mA	-53		53	100% tested for CASR/CKSR
Temperature coefficient of $V_{REF}$	$TCV_{REF}$	ppm/K		$\pm 5$	$\pm 50$	Internal reference for CASR/CKSR
Temperature coefficient of $V_{OUT}$ @ $I_p = 0\text{ A}$	$TCV_{OUT}$	ppm/K		$\pm 7.5$	$\pm 70$	ppm/K of $2.5\text{ V} - 40^\circ\text{C} \dots 85^\circ\text{C}$ for CAS
		ppm/K		$\pm 2.3$	$\pm 20$	ppm/K of $2.5\text{ V} - 40^\circ\text{C} \dots 85^\circ\text{C}$ for CASR / CKSR
Theoretical sensitivity	Gth	mV/A		41.67		$625\text{ mV} / I_{PN}$
Sensitivity error	$\epsilon_G$	%	-0.7		0.7	100% tested
Temperature coefficient of G	TCG	ppm/K			$\pm 40$	$-40^\circ\text{C} \dots 85^\circ\text{C}$
Linearity error	$\epsilon_L$	% of $I_{PN}$	-0.1		0.1	
Magnetic offset current ( $10 \times I_{PN}$ ) referred to primary	$I_{OM}$	A	-0.1		0.1	
Output current noise (spectral density) rms 100 Hz .. 100 kHz referred to primary	$i_{no}$	$\mu\text{A}/\text{Hz}^{1/2}$		90		$R_L = 1\text{ k}\Omega$ for CAS
		$\mu\text{A}/\text{Hz}^{1/2}$		20		$R_L = 1\text{ k}\Omega$ for CASR / CKSR
Peak-peak output ripple at oscillator frequency $f = 450\text{ kHz}$ (typ.)	-	mV		15	60	$R_L = 1\text{ k}\Omega$
Reaction time @ 10 % of $I_{PN}$	$t_{ra}$	$\mu\text{s}$			0.3	$R_L = 1\text{ k}\Omega$ $di/dt = 44\text{ A}/\mu\text{s}$
Response time @ 90 % of $I_{PN}$	$t_r$	$\mu\text{s}$			0.3	$R_L = 1\text{ k}\Omega$ $di/dt = 44\text{ A}/\mu\text{s}$
Frequency bandwidth ( $\pm 1\text{ dB}$ )	BW	kHz	200			$R_L = 1\text{ k}\Omega$
Frequency bandwidth ( $\pm 3\text{ dB}$ )	BW	kHz	300			$R_L = 1\text{ k}\Omega$
Overall accuracy	$X_G$	% of $I_{PN}$			1.9	for CAS
					1.2	for CASR/CKSR
Overall accuracy @ $T_A = 85^\circ\text{C}$	$X_G$	% of $I_{PN}$			3.9	for CAS
					1.9	for CASR / CKSR
Accuracy	X	% of $I_{PN}$			0.8	
Accuracy @ $T_A = 85^\circ\text{C}$	X	% of $I_{PN}$			2.7	for CAS
					1.5	for CASR / CKSR

## Electrical data CAS/CASR/CKSR 25-NP

At  $T_A = 25^\circ\text{C}$ ,  $V_C = +5\text{ V}$ ,  $N_p = 1$  turn,  $R_L = 10\text{ k}\Omega$ , (internal reference for CASR & CKSR models) unless otherwise noted.

Parameter	Symbol	Unit	Min	Typ	Max	Comment
Primary nominal current rms	$I_{PN}$	A		25		
Primary current, measuring range	$I_{PM}$	A	-85		85	
Number of primary turns	$N_p$	-		1,2,3		for CAS / CASR
		-		1,2,3,4		for CKSR
Supply voltage	$V_C$	V	4.75	5	5.25	
Current consumption	$I_C$	mA		$15 + \frac{I_p(\text{mA})}{N_s}$	$20 + \frac{I_p(\text{mA})}{N_s}$	$N_s = 1731$ turns
Reference voltage @ $I_p = 0\text{ A}$	$V_{REF}$	V	2.495	2.5	2.505	Internal reference for CASR / CKSR
External reference voltage	$V_{REF}$	V	0		4	for CASR / CKSR
Output voltage	$V_{OUT}$	V	0.375		4.625	
Output voltage @ $I_p = 0\text{ A}$	$V_{OUT}$	V		2.5		for CAS
				$V_{REF}$		for CASR / CKSR
Electrical offset voltage	$V_{OE}$	mV	-6.25		6.25	100% tested $V_{OUT} - 2.5\text{ V}$ for CAS $V_{OUT} - V_{REF}$ for CASR / CKSR
			-1.35		1.35	
Electrical offset current referred to primary	$I_{OE}$	A	-0.25		0.25	100% tested for CAS
		mA	-54		54	100% tested for CASR / CKSR
Temperature coefficient of $V_{REF}$	$TCV_{REF}$	ppm/K		$\pm 5$	$\pm 50$	Internal reference for CASR / CKSR
Temperature coefficient of $V_{OUT}$ @ $I_p = 0\text{ A}$	$TCV_{OUT}$	ppm/K		$\pm 6.5$	$\pm 60$	ppm/K of $2.5\text{ V} - 40^\circ\text{C} \dots 85^\circ\text{C}$ for CAS
				$\pm 1.4$	$\pm 10$	ppm/K of $2.5\text{ V} - 40^\circ\text{C} \dots 85^\circ\text{C}$ for CASR / CKSR
Theoretical sensitivity	Gth	mV/A		25		$625\text{ mV} / I_{PN}$
Sensitivity error	$\epsilon_G$	%	-0.7		0.7	100% tested
Temperature coefficient of G	$TCG$	ppm/K			$\pm 40$	$-40^\circ\text{C} \dots 85^\circ\text{C}$
Linearity error	$\epsilon_L$	% of $I_{PN}$	-0.1		0.1	
Magnetic offset current ( $10 \times I_{PN}$ ) referred to primary	$I_{OM}$	A	-0.1		0.1	
Output current noise (spectral density) rms 100 Hz .. 100 kHz referred to primary	$i_{no}$	$\mu\text{A}/\text{Hz}^{1/2}$		150		$R_L = 1\text{ k}\Omega$ for CAS
				20		$R_L = 1\text{ k}\Omega$ for CASR / CKSR
Peak-peak output ripple at oscillator frequency $f = 450\text{ kHz}$ (typ.)	-	mV		10	40	$R_L = 1\text{ k}\Omega$
Reaction time @ 10 % of $I_{PN}$	$t_{ra}$	$\mu\text{s}$			0.3	$R_L = 1\text{ k}\Omega$ $di/dt = 68\text{ A}/\mu\text{s}$
Response time @ 90 % of $I_{PN}$	$t_r$	$\mu\text{s}$			0.3	$R_L = 1\text{ k}\Omega$ $di/dt = 68\text{ A}/\mu\text{s}$
Frequency bandwidth ( $\pm 1\text{ dB}$ )	BW	kHz	200			$R_L = 1\text{ k}\Omega$
Frequency bandwidth ( $\pm 3\text{ dB}$ )	BW	kHz	300			$R_L = 1\text{ k}\Omega$
Overall accuracy	$X_G$	% of $I_{PN}$			1.8	for CAS
					1	for CASR / CKSR
Overall accuracy @ $T_A = 85^\circ\text{C}$	$X_G$	% of $I_{PN}$			3.5	for CAS
					1.5	for CASR / CKSR
Accuracy	X	% of $I_{PN}$			0.8	
Accuracy @ $T_A = 85^\circ\text{C}$	X	% of $I_{PN}$			2.5	for CAS
					1.3	for CASR / CKSR

## Electrical data CAS / CASR / CKSR 50-NP

At  $T_A = 25^\circ\text{C}$ ,  $V_C = +5\text{ V}$ ,  $N_P = 1$  turn,  $R_L = 10\text{ k}\Omega$ , (internal reference for CASR & CKSR models) unless otherwise noted.

Parameter	Symbol	Unit	Min	Typ	Max	Comment
Primary nominal current rms	$I_{PN}$	A		50		
Primary current, measuring range	$I_{PM}$	A	-150		150	
Number of primary turns	$N_P$	-		1,2,3		for CAS / CASR
		-		1,2,3,4		for CKSR
Supply voltage	$V_C$	V	4.75	5	5.25	
Current consumption	$I_C$	mA		$15 + \frac{I_p(\text{mA})}{N_s}$	$20 + \frac{I_p(\text{mA})}{N_s}$	$N_s = 966$ turns
Reference voltage @ $I_p = 0\text{ A}$	$V_{REF}$	V	2.495	2.5	2.505	Internal reference for CASR / CKSR
External reference voltage	$V_{REF}$	V	0		4	for CASR / CKSR
Output voltage	$V_{OUT}$	V	0.375		4.625	
Output voltage @ $I_p = 0\text{ A}$	$V_{OUT}$	V		2.5		for CAS
		V		$V_{REF}$		for CASR / CKSR
Electrical offset voltage	$V_{OE}$	mV	-5.8		5.8	100% tested $V_{OUT} - 2.5\text{ V}$ for CAS $V_{OUT} - V_{REF}$ for CASR / CKSR
		mV	-0.725		0.725	
Electrical offset current referred to primary	$I_{OE}$	A	-0.46		0.46	100% tested for CAS
		mA	-58		58	100% tested for CASR / CKSR
Temperature coefficient of $V_{REF}$	$TCV_{REF}$	ppm/K		$\pm 5$	$\pm 50$	Internal reference for CASR / CKSR
Temperature coefficient of $V_{OUT}$ @ $I_p = 0\text{ A}$	$TCV_{OUT}$	ppm/K		$\pm 6$	$\pm 60$	ppm/K of $2.5\text{ V} - 40^\circ\text{C} \dots 85^\circ\text{C}$ for CAS
				$\pm 0.7$	$\pm 7$	ppm/K of $2.5\text{ V} - 40^\circ\text{C} \dots 85^\circ\text{C}$ for CASR / CKSR
Theoretical sensitivity	$G_{th}$	mV/A		12.5		$625\text{ mV} / I_{PN}$
Sensitivity error	$\epsilon_G$	%	-0.7		0.7	100% tested
Temperature coefficient of G	$TCG$	ppm/K			$\pm 40$	$-40^\circ\text{C} \dots 85^\circ\text{C}$
Linearity error	$\epsilon_L$	% of $I_{PN}$	-0.1		0.1	
Magnetic offset current ( $10 \times I_{PN}$ ) referred to primary	$I_{OM}$	A	-0.1		0.1	
Output current noise (spectral density) rms 100 Hz .. 100 kHz referred to primary	$i_{no}$	$\mu\text{A}/\text{Hz}^{1/2}$		300		$R_L = 1\text{ k}\Omega$ for CAS
				20		$R_L = 1\text{ k}\Omega$ for CASR / CKSR
Peak-peak output ripple at oscillator frequency $f = 450\text{ kHz}$ (typ.)	-	mV		5	20	$R_L = 1\text{ k}\Omega$
Reaction time @ 10 % of $I_{PN}$	$t_{ra}$	$\mu\text{s}$			0.3	$R_L = 1\text{ k}\Omega$ $di/dt = 100\text{ A}/\mu\text{s}$
Response time @ 90 % of $I_{PN}$	$t_r$	$\mu\text{s}$			0.3	$R_L = 1\text{ k}\Omega$ $di/dt = 100\text{ A}/\mu\text{s}$
Frequency bandwidth ( $\pm 1\text{ dB}$ )	BW	kHz	200			$R_L = 1\text{ k}\Omega$
Frequency bandwidth ( $\pm 3\text{ dB}$ )	BW	kHz	300			$R_L = 1\text{ k}\Omega$
Overall accuracy	$X_G$	% of $I_{PN}$			1.7	for CAS
					0.9	for CASR / CKSR
Overall accuracy @ $T_A = 85^\circ\text{C}$	$X_G$	% of $I_{PN}$			3.4	for CAS
					1.3	for CASR / CKSR
Accuracy	X	% of $I_{PN}$			0.8	
Accuracy @ $T_A = 85^\circ\text{C}$	X	% of $I_{PN}$			2.5	for CAS
					1.2	for CASR / CKSR

# PCB footprints

## CAS Series

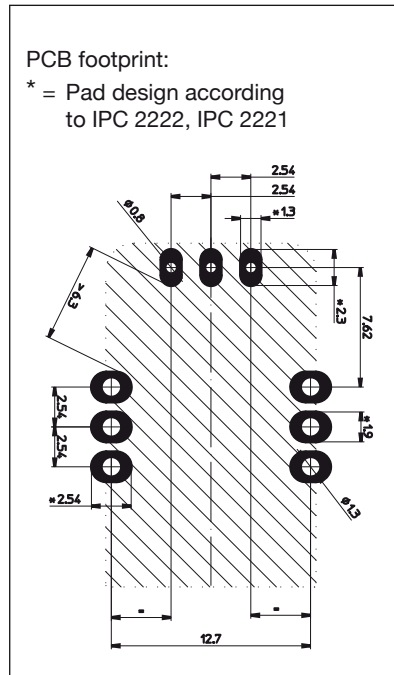

## CASR Series

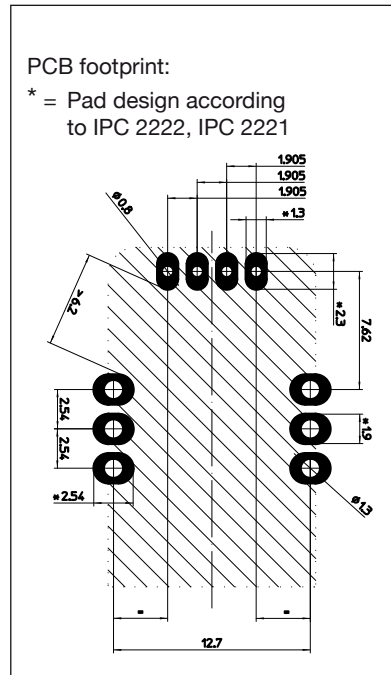

## CKSR Series

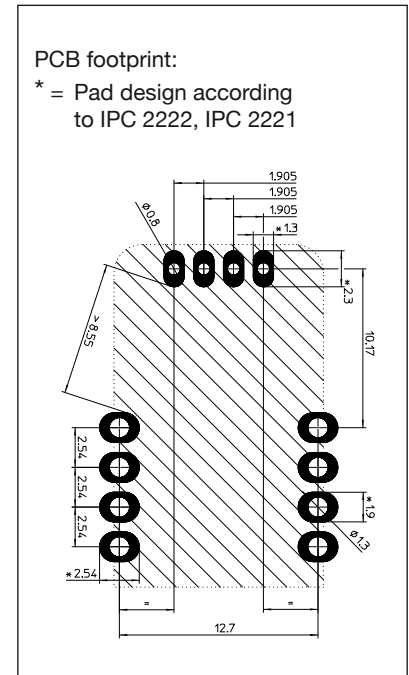

Dimensions in mm. 1 mm = 0.0394 inches

### Assembly on PCB

Recommended PCB hole diameter	1.3 mm for primary pin 0.8 mm for secondary pin
Maximum PCB thickness	2.4 mm
Wave soldering profile	maximum 260°C for 10 s
No clean process only.	

### Safety



This transducer must be used in electric/electronic equipment with respect to applicable standards and safety requirements in accordance with the manufacturer's operating instructions



Caution, risk of electrical shock

When operating the transducer, certain parts of the module can carry hazardous voltage (eg. primary busbar, power supply).

Ignoring this warning can lead to injury and/or cause serious damage.

This transducer is a built-in device, whose conducting parts must be inaccessible after installation.

A protective housing or additional shield could be used.

Main supply must be able to be disconnected.

Dimensions (in mm. General linear tolerance  $\pm 0.25$  mm)

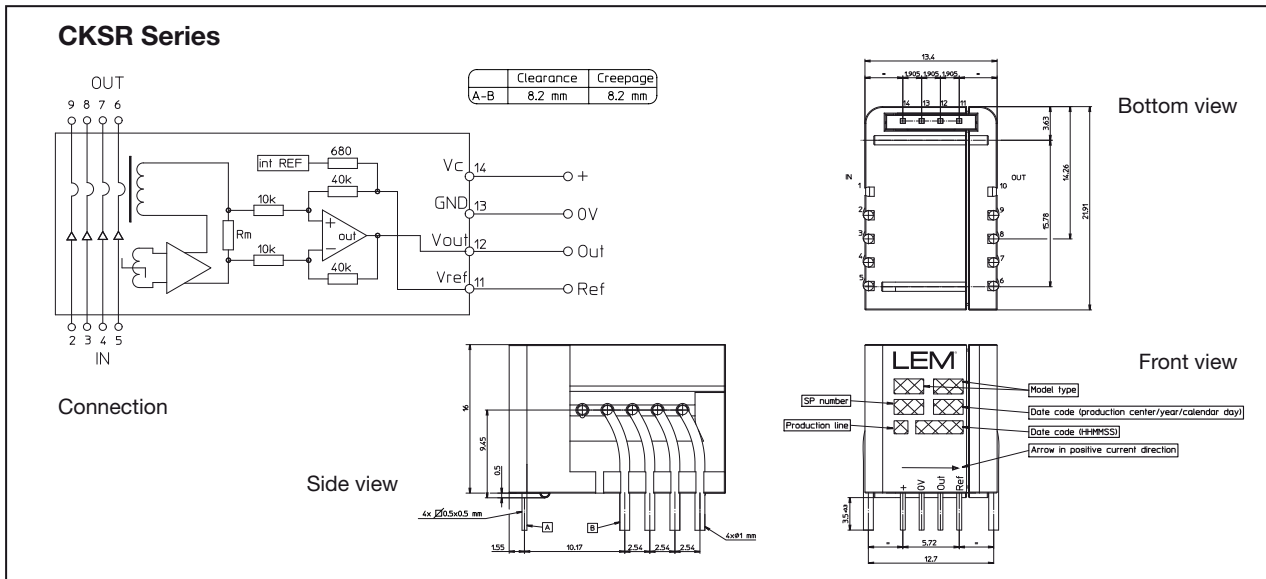
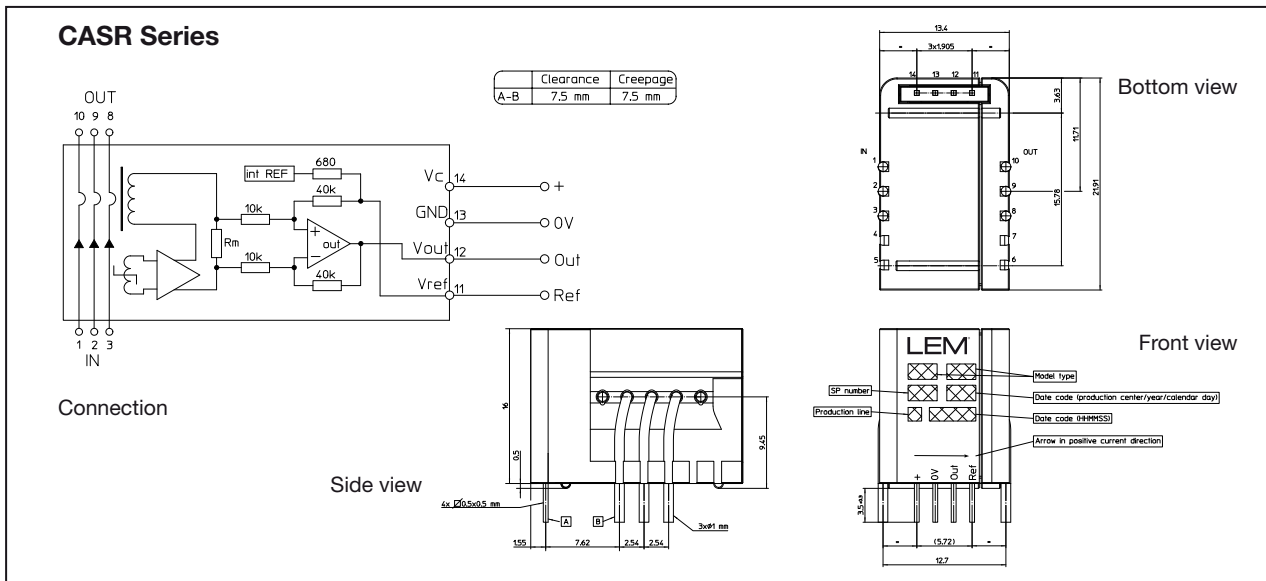
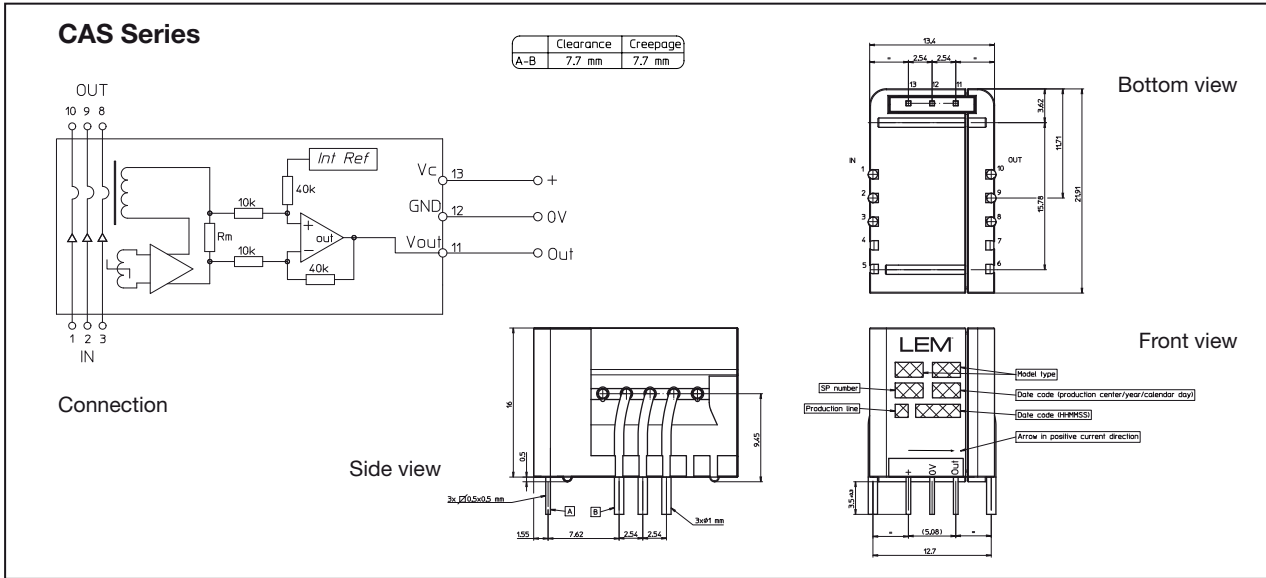



## **5 Year Warranty on LEM Transducers**

We design and manufacture high quality and highly reliable products for our customers all over the world.

We have delivered several million current and voltage transducers since 1972 and most of them are still being used today for traction vehicles, industrial motor drives, UPS systems and many other applications requiring high quality standards.

The LEM 5-year warranty applies to all LEM transducers and is valid in addition to the legal warranty.

The warranty granted on LEM transducers is for a period of 5 years (60 months) from the date of their delivery.

During this period LEM shall replace or repair all defective parts at its' cost (provided the defect is due to defective material or workmanship).

Additional claims as well as claims for the compensation of damages, which do not occur on the delivered material itself, are not covered by this warranty.

All defects must be notified to LEM immediately and faulty material must be returned to the factory along with a description of the defect.

Warranty repairs and or replacements are carried out at LEM's discretion.

The customer bears the transport costs. An extension of the warranty period following repairs undertaken under warranty cannot be granted.

The warranty becomes invalid if the buyer has modified or repaired, or has had repaired by a third party the material without LEM's written consent.

The warranty does not cover any damage caused by incorrect conditions of use and cases of force majeure.

No responsibility will apply except legal requirements regarding product liability.

The warranty explicitly excludes all claims exceeding the above conditions.

LEM, April 1. 2008

A handwritten signature in black ink, appearing to read "P. Van Iseghem".

Paul Van Iseghem  
President & CEO LEM

Europe • Middle East

**Austria**  
LEM Components  
Am Concorde Park 2/F  
A-2320 Schwechat  
Tel. +43 1 903 60 10 40  
Fax +43 1 903 60 10 42  
e-mail: jsc@lem.com

**Belarus and Baltic Republics**  
DACPOL Sp. z. o. o  
Ul. Pulawska 34  
PL-05-500 Piaseczno  
Tel. +48 22 70335100  
Fax +48 22 7035101  
e-mail: dacpol@dacpol.com.pl

**BeNeLux**  
LEM Belgium sprl-bvba  
Route de Petit-Roeulx, 95  
B-7090 Braine-le-Comte  
Tel. : +32 67 55 01 14  
Fax : +32 67 55 01 15  
e-mail : lbe@lem.com

**Bosnia, Croatia, Herzegovina, Serbia and Slovenia**  
Proteus Electric S.r.l.  
Via di Noghère 94/1  
I-34147 Muggia-Aquilina  
Tel. +39 040 23 21 88  
Fax +39 040 23 24 40  
e-mail: dino.fabiani@proteuselectric.it

**Czech Republic, Slovakia PE & ED Spol. S.R.O.**  
Koblovská 101/23  
CZ-71100 Ostrava/Koblov  
Tel. +420 59 6239256  
Fax +420 59 6239531  
e-mail: peedova@peed.cz

**Denmark**  
Motron A/S  
Torsovej 4  
DK-8240 Risskov  
Tel. +45 87 36 86 00  
Fax +45 87 36 86 01  
e-mail: motron@motron.dk

**Finland**  
ETRA Electronics Oy  
Lampputie 2  
FI-00740 Helsinki  
Tel. +358 207 65 160  
Fax +358 207 65 23 11  
e-mail: markku.soittila@etra.fi

**Field Applications Engineer**  
Mr. Pasi Leveälähti  
Kausantie 668, 17150 Urajärvi  
Tel. +358 50 5754435  
Fax +358 37667 141  
e-mail: pli@lem.com

**France**  
LEM France Sarl  
15, avenue Galois  
F. 92340 Bourg-La-Reine  
Tel. +33 1 45 36 46 20  
Fax +33 1 45 36 06 16  
e-mail: lfr@lem.com

**Germany**  
Central Office:  
LEM Deutschland GmbH  
Frankfurter Strasse 74  
D-64521 Gross-Gerau  
Tel. +49 6152 9301 0  
Fax +49 6152 8 46 61  
e-mail: postoffice.lde@lem.com

**Hauber & Graf Electronics GmbH**  
Bavaria / Baden Württemberg  
Wahlwiesenstr. 3  
D-71711 Steinheim  
Tel. +49 7144 28 15 03/04  
Fax +49 7144 28 15 05  
e-mail: electronics@hauber-graf.de

**Hungary**  
Orszaczky Trading LTD.  
Korányi Sandor U, 28  
H-1089 Budapest  
Tel. +36 1 314 4225  
Fax +36 1 324 8757  
e-mail: info@orszaczky.hu

**Iran**  
MGIT  
Mansoureh Tehrani  
IR-Tehran  
Tel. +9821 22 37 46 05  
Fax +9821 22 37 46 04  
Mobile + 98912 113 81 56  
e-mail: mgt@tavana.net

**Israel**  
Ofer Levin Technological Application  
PO Box 18247  
IL- Tel Aviv 611 81  
Tel.+972 3 5586279  
Fax +972 3 5586282  
e-mail: ol\_teap@netvision.net.il

**Italy**  
LEM Italia Srl  
via V. Bellini, 7  
I-35030 Selvazzano Dentro, PD  
Tel. +39 049 805 60 60  
Fax +39 049 805 60 59  
e-mail: lit@lem.com

**Norway**  
Holst & Fleischer A/S  
Stansveien 6B  
N-0975 Oslo  
Tel. +47 2333 8500  
Fax +47 2333 8501  
e-mail: hf@hf-eklektro.no

**Poland**  
DACPOL Sp. z o.o.  
Ul. Pulawska 34  
PL-05-500 Piaseczno  
Tel. +48 22 70335100  
Fax +48 22 7035101  
e-mail: dacpol@dacpol.com.pl

**Portugal**  
Qenergia, Lda  
Praceta Cesário Verde - 10 S/Cave  
P-2745-740 Massamá  
Tel. +351 214 309320  
Fax +351 214 309299  
e-mail: qenergia@qenergia.pt

**Romania**  
SYSCOM -18 Srl.  
Protopopescu 10, bl. 4. ap 2 Sector 1  
RO-011728 Bucharest  
Tel. +40 21 310 26 78  
Fax +40 21 316 91 76  
e-mail: george.barbalata@syscom18.com

**Russia**  
Central Office:  
TVELEM  
Marshall Budionny Str.11  
170023 Tver / Russia  
Tel. +7 48 22 743 951  
Fax +7 48 22 743 955  
e-mail: tvelem@lem.com

**TVELEM**  
Baltijskaja str., 13, Room 19  
125190 Moscow  
Tel. +7 495 363 07 67  
Fax +7 495 363 07 67  
e-mail: tvelem@alo.ru

**TVELEM**  
V.O., 2 linia, 19, Liter „A“  
199053 S. Petersburg  
Tel. +7 812 323 83 83  
Fax +7 812 323 83 83  
e-mail: info@maglem.ru

**Slovenia**  
Proteus Electric  
Via di Noghère 94/1  
I-34147 Muggia-Aquilina  
Tel. +39 040 23 21 88  
Fax +39 040 23 24 40  
e-mail: dino.fabiani@proteuselectric.it

**Spain**  
LEM Components  
Apartado 142  
E-08500 VIC  
Tel. +34 93 886 02 28  
Fax +34 93 886 60 87  
e-mail: slul@lem.com

**Sweden**  
ADIATOR A.B.  
Hälsingegatan 40  
SE-10435 Stockholm  
Tel. +46 8 729 1700  
Fax +46 8 729 1717  
e-mail: info@adiator.se

**Beving Elektronik AB**  
Storsåtragränd 10  
S. 12739 Skärholmen  
Tel. +46 8 680 1199  
Fax +46 8 680 1188  
e-mail: lars.g.pahlsson@beving.se

**Switzerland**  
SIMPEX Electronic AG  
Binzackerstrasse 33  
CH-8622 Wetzikon  
Tel. +41 1 931 10 10  
Fax +41 1 931 10 11  
e-mail: contact@simpex.ch

**LEM SA**  
8, Chemin des Aulx  
CH-1228 Plan-les-Ouates  
Tel. +41 22 706 11 11  
Fax +41 22 794 94 78  
e-mail: lsa@lem.com

**Turkey**  
Özdisan Elektronik Pazarlama  
Galata Kulesi Sokak N° 34  
TR-80020 Kuledibi / Istanbul  
Tel. +90 212 2436946  
Fax +90 212 2436946  
e-mail: oabdi@ozdisan.com

**Ukraine**  
"SP DACPOL" Co Ltd.  
Snovskaya str., 20  
UA-02090, KIEV, UKRAINE  
Tel. +380 44 501 93 44  
Fax +380 44502 64 87  
e-mail: kiev@dacpol.com

**United Kingdom and Eire**  
LEM UK Ltd  
West Lanes Investment Centre  
Whitemoss Business Park  
Skelmersdale, Lanes WN8 9TG  
Tel. +44 1 695 71 25 60  
Fax +44 1 695 71 25 61  
e-mail: luk@lem.com

Africa • America

**Argentina**  
Semak S.A.  
Av. Belgrano 1580, 5° Piso  
AR-1093 BUENOS AIRES  
Tel. +54 11 4381 2108  
Fax +54 11 4383 7420  
e-mail: mpedro@semak.com.ar

**Brazil**  
AMDS4 Imp. Exp. e Com. de Equip. Electr. Ltda.  
Rua Doutor Ulhôa Cintra, 489,  
Centro 13800-061 -  
Mojí Mirim - Sao Paulo - Brazil  
Tel. +55 19 3806 1950 / 8509  
Fax +55 19 3806 8422  
e-mail: jeduardo@amds4.com.br

**Canada Ontario East**  
Optimum Components Inc.  
7750 Birchmount Road Unit 5  
CAN-Markham ON L3R 0B4  
Tel. +1 905 477 9393  
Fax +1 905 477 6197  
e-mail: mikkep@optimumcomponents.com

**Canada Manitoba West**  
William P. Hall Contract Services  
7045 NE 137th st.  
CAN-Kirkland,  
Washington 98034  
Tel. +1 425 820 6216  
Fax +1 206 390 2411

**South Africa**  
Denver Technical Products Ltd.  
P.O. Box 75810  
SA-2047 Garden View  
Tel. +27 11 626 20 23  
Fax +27 11 626 20 09  
e-mail: denvertech@pixie.co.za

**U.S.A.**  
Central Office:  
LEM U.S.A., Inc.  
11665 West Bradley Road  
USA Milwaukee, WI 53224  
Tel. +1 414 353 07 11  
Tel. +48 22 70335100  
Toll free: 800 236 53 66  
Fax +1 414 353 07 33  
e-mail: lus@lem.com

**LEM U.S.A., Inc**  
991, Michigan Avenue.  
USA-Columbus, OH 43201  
Tel. +1 414 353 07 11 ext. 200  
Fax +1 614 540 74 36  
Mobile +1 614 306 73 02  
e-mail: atfg@lem.com

**LEM U.S.A., Inc.**  
37 Thornton Ferry Road II  
USA-Amherst, NH 03031  
Tel. +1 800 236 53 66 ext. 202  
Fax +1 603 672 71 59  
e-mail: gap@lem.com

**LEM U.S.A., Inc.**  
6275 Simms st.  
Suite # 110  
USA Arvada, CO 80004  
Tel. +1 800 236 53 66 ext. 201  
Fax +1 303 403 15 89  
e-mail: dlw@lem.com

Asia • Pacific

**Australia and New Zealand**  
Fastron Technologies Pty Ltd.  
25 Kingsley Close  
Rowville - Melbourne -  
Victoria 3178  
Tel. +61 3 9763 5155  
Fax +61 3 9763 5166  
e-mail: sales@fastron.com.au

**China**  
Beijing LEM Electronics Co. Ltd  
No. 1 Standard Factory  
Building B, Airport Industry  
Area, Beijing, China  
Post code : 101300  
Tel. +86 10 80 48 31 78  
Fax +86 10 80 48 43 03  
e-mail: bj@lem.com

**Beijing LEM Electronics Co. Ltd**  
Shanghai Office  
Room 807  
728, Xinhua Road  
Shanghai, 200052 P.R. China  
Tel. +86 21 3226 0881  
Fax +86 21 5258 2262  
e-mail: bj@lem.com

**Beijing LEM Electronics Co. Ltd**  
Shenzhen Office  
Room 1205  
6021 Shennan Road  
Shenzhen, 518040 P.R. China  
Tel. +86 755 3334 0779  
+86 755 3336 9609  
Fax +86 755 3334 0780  
e-mail: bj@lem.com

**India**  
LEM Management Services SA  
India Branch Office  
Mr. Sudhir Khandekar  
Tel. +91 98 331 35 223  
e-mail: skh@lem.com

**Globetek**  
122/49, 27th Cross  
7th Block, Jayanagar  
IN-Bangalore-560082  
Tel. +91 80 2 663 57 20  
Fax +91 80 2 653 40 20  
e-mail: globetek@vsnl.com

**Japan**  
LEM Japan K.K.  
2-1-2 Nakamachi  
J-194-0021Machida-Tokyo  
Tel. +81 4 2725 8151  
Fax +81 4 2728 8119  
e-mail: lj@lem.com

**LEM Japan K.K.**  
1-8-33-607 Nishimiyahara  
Yodogawa-Ku Osaka  
532-0004 Japan  
Tel. +81 6 6395 4073  
Fax +81 6 6395 4079  
e-mail: lj@lem.com

**Korea**  
S&H Trading  
#Ra-3701, Jungang Yootong Danji  
1258, Kurobon-Dong, Kuro-Ku,  
K-Seoul, 152-721  
Tel. +82 2 2686 83 46  
+82 2 2613 83 45  
Fax +82 2 2686 83 47  
e-mail: snhlim@yahoo.co.kr

**Young Woo Ind. Co.**  
C.P.O. Box 10265  
K-Seoul  
Tel. +82 312 66 88 58  
Fax +82 312 66 88 57  
e-mail: c.k.park@ywoo.co.kr

**Malaysia**  
Acei Systems SDN BHD  
1A & 1A-1, Lintasan  
Perajurit 6,  
Taman Perak  
31400 Ipoh  
Perak Darul Ridzuan  
Malaysia  
Tel. +60 5 547 0761/0771  
Fax +60 5 547 1518  
e-mail: enquiry@aceisys.com.my

**Singapore**  
Overseas Technology Center Pte Ltd.  
Blk 1003 Bukit  
Merah Central  
Unit 06-16  
Technopreneur Centre  
RS-159 836 Singapore  
Tel. +65 6 272 60 77  
Fax +65 6 278 21 34  
e-mail: otcp@singnet.com.sg

**Taiwan**  
POWERTRONICS CO. LTD  
2F, No 138, Sec. 3  
Chung-shing Rd, Shing-Tien,  
Taipei -Hsien 231, Taiwan, R.O.C.  
Tel. +886 2 2915 7000  
Fax +886 2 2915 3910  
e-mail: sales@powertronics.com.tw

**Tope Co., Ltd.**  
3F-4, 716 Chung Cheng Road  
Chung Ho City, Taipei Hsien,  
Taiwan 235, R.O.C  
Tel. +886 2 8228 0658  
Fax +886 2 8228 0659  
e-mail: tope@ms1.hinet.net



LEM International SA  
8, Chemin des Aulx, CH-1228 Plan-les-Ouates  
Tel. +41/22/7 06 11 11, Fax +41/22/7 94 94 78  
e-mail: lsa@lem.com; www.lem.com

Publication CH 29100 E/US (02.09 • 6.5/3.5 • CDH)

Distributor