

Current Transducer FRS-Sxlx series $I_{PN} = 1000\text{ A} \dots 3000\text{ A}$

Ref: FRS 1000-Sxlx; FRS 1500-Sxlx; FRS 2000-Sxlx; FRS 2500-Sxlx;
FRS 3000-Sxlx

For the electronic measurement of current: DC, AC, pulsed..., with galvanic separation between the primary and the secondary circuit.



Features

- Hall effect **Open Loop Coreless Integral** current transducer
- Uni- or Bi-directional ¹⁾ measurement of primary current up to 9000 A
- Instantaneous 4-20 mA current output
- Power supply +12 or +24 V DC
- Galvanic separation between primary and secondary circuit
- Factory calibrated
- High bandwidth > 1 MHz
- Very low delay time < 400 ns.

Advantages

- Wide measurement range
- No magnetic offset
- Low consumption and low losses
- Wide range of rectangular busbar dimensions
- Light weight design
- M12 field connector.

Applications

- Wind turbine power converter
- Electrolyser
- High power drives.

Standards

- IEC 62477-1: 2022
- IEC 61800-5-1: 2022
- IEC 62109-1: 2010
- IEC 61010-1: 2010
- EN 50155: 2021
- IEC 61992-7-2: 2006
- UL 61010-1: 3ED 2022.

Application Domains

- Industrial
- Traction
- Trackside.

Note: ¹⁾ see reference table on [page 12](#).

Safety



Caution

Ignoring the warnings can lead to serious injury and/or cause damage. The current transducer may only be installed and put into operation by qualified personnel that have received and appropriate training on applicable safety precautions.

If the device is used in a way that is not specified by the manufacturer, the protection provided by the device may be compromised. Always inspect the transducer and connecting cable before using this product and do not use it if damaged.

The installation shall guarantee the maximum primary conductor temperature, respect clearance and creepage distances, minimize electric and magnetic coupling. Unless otherwise specified the transducer can be mounted in any orientation using its mounting holes. Primary conductors should not exert any force on the transducer.



Caution, risk of electrical shock

This transducer must be used in limited-energy secondary circuits SELV according to IEC 61010-1, in electric/electronic equipment with respect to applicable standards and safety requirements in accordance with the manufacturer's operating specifications.

Use caution during installation and use of this product; certain parts of the module can carry hazardous voltages and high currents (e.g. power supply, primary conductor).

Ignoring this warning can lead to injury and and/or cause serious damage.

De-energize all circuits and hazardous live parts before installing the product.

All installations, maintenance, servicing operations and use must be carried out by trained and qualified personnel practicing applicable safety precautions.

This transducer is a build-in device, whose hazardous live parts must be inaccessible after installation.

This transducer must be mounted in a suitable end-enclosure.

Besides make sure to have a distance of minimum 30 mm between the primary terminals of the transducer and other neighboring components.

Main supply must be able to be disconnected.

Never connect or disconnect the external power supply while the primary circuit is connected to live parts.

Always wear protective clothing and gloves if hazardous live parts are present in the installation where the measurement is carried out.

This transducer is a built-in device, not intended to be cleaned with any product. Nevertheless if the user must implement cleaning or washing process, validation of the cleaning program has to be done by himself.

Do not dispose of this product as unsorted municipal waste.

Contact a qualified recycler for disposal.

Absolute maximum ratings

Parameter	Symbol	Unit	Value
Maximum supply voltage (not destructive)	$\pm U_{C\max}$	V	-0.3 ... 32 V DC
Maximum primary conductor temperature	$T_{B\max}$	°C	105
Electrostatic discharge voltage (HBM - Human Body Model)	$U_{ESD\ HBM}$	kV	2

Stresses above these ratings may cause permanent damage.
Exposure to absolute maximum ratings for extended periods may degrade reliability.

Insulation coordination

Parameter	Symbol	Unit	Value	Comment
RMS voltage for AC insulation test, 50 Hz, 1 min	U_d	kV	12	
Impulse withstand voltage 1.2/50 μ s	U_{Ni}	kV	44	Target, TBC
RMS voltage for AC insulation routine test, 50 Hz, 2"		kV	5.3	Industry application ¹⁾
RMS voltage for AC insulation routine test, 50 Hz, 5"		kV	18.5	Traction application ¹⁾
Partial discharge RMS type test voltage ($q_m < 10$ pC)	U_t	V	2480	Primary/Secondary Industry application ^{1) 2)}
Partial discharge RMS type test voltage ($q_m < 10$ pC)	U_t	V	4840	Primary/Secondary Traction application ^{1) 2)}
Minimum clearance (pri. - sec.)	d_{Cl}	mm	> 72	Shortest distance through air
Minimum creepage distance (pri. - sec.)	d_{Cp}	mm	> 100	Shortest path along device body
Case material	-	-	V0	According to UL 94
Comparative tracking index	<i>CTI</i>		600	
Application example Industry Working voltage		V	1500 1000	Reinforced insulation non-uniform According to: IEC 61800-5-1, CAT III PD2 IEC 62477-1, CAT IV PD3 IEC 61010-1, CAT IV PD3
Application example Trackside/Traction Nominal voltage Rated insulation voltage	U_N U_{Nm}	V	3000 3600/3700	Reinforced insulation non-uniform According to: IEC 62497-1, CAT III PD3

Environmental and mechanical characteristics

Parameter	Symbol	Unit	Min	Typ	Max	Comment
Ambient operating temperature	T_A	°C	-40		+85	
Ambient storage temperature	$T_{A\ st}$	°C	-40		+90	
Mass	m	g		472		

Notes: ¹⁾ See reference table on [page 12](#)

²⁾ Guaranteed with a centered busbar of 104 x 22 mm maximum dimension with an edge chamfer of 1.5 mm or any other shape and layout providing a minimum clearance of 3 mm between the bare metal and the inner wall of the transducer.

Electrical data FRS 1000-Sxlx

 At $T_A = 25\text{ °C}$, $U_C = +24\text{ V}$, $R_M = 100\text{ }\Omega$, unless otherwise noted (see Min, Max, typ, definition paragraph in [page 9](#)).

Parameter	Symbol	Unit	Min	Typ	Max	Comment
Primary nominal current	I_{PN}	A		1000		See ¹⁾
Primary current, measuring range	I_{PM}	A	-3000 0		3000 3000	SBlx version SUIx version
Supply voltage	U_C	V	10	12 or 24	28	See ²⁾
Current consumption	I_C	mA		$120 + 1.2 \times I_{out}$ $60 + 1.2 \times I_{out}$	180 120	@ $U_C = 12\text{ V DC}$ @ $U_C = 24\text{ V DC}$
Output current range @ $\pm I_{PM}$ ³⁾ @ 0 ... I_{PM}	I_{out}	mA	4 4		20 20	SBlx version $I_{out} = 12\text{ mA}$ @ $I_p = 0$ SUIx version $I_{out} = 4\text{ mA}$ @ $I_p = 0$
Measuring resistance	R_M	Ω	10	100	240	
Electrical offset current referred to primary	I_{OE}	A	-4.5		4.5	
Temperature coefficient of I_{OE} referred to primary	TCI_{OE}	mA/K	-450 -300		450 300	-40 °C ... 25 °C 25 °C ... 85 °C
Nominal sensitivity	S_N	$\mu\text{A/A}$		2.667 5.333		SBlx version SUIx version
Magnetic offset current (@ I_{PN}) referred to primary	I_{OM}	A		none		No magnetic core inside, OLCI technology
Temperature coefficient of S	TCS	ppm/K	-120		120	-40 °C ... +85 °C
Linearity error 0 ... I_{PM}	ϵ_L	% of I_{PM}	-0.35		0.35	
Sum of sensitivity & Linearity error 0 ... I_{PM}	ϵ_{SL}	% of I_{PM}	-0.5		0.5	Primary busbar centered No return busbar considered ^{4) 6)}
Total error @ 25 °C @ $I_p = 0$ @ $I_p = \pm I_{PM}$	ϵ_{tot}	% of I_{PM}	-0.15 -0.65		0.15 0.65	Primary busbar centered No return busbar considered ^{4) 6)}
Total error @ -40 °C @ $I_p = 0$ @ $I_p = \pm I_{PM}$	ϵ_{tot}	% of I_{PM}	-0.99 -1.55		0.99 1.55	Primary busbar centered No return busbar considered ^{4) 6)}
Total error @ 85 °C @ $I_p = 0$ @ $I_p = \pm I_{PM}$	ϵ_{tot}	% of I_{PM}	-0.62 -1.25		0.62 1.25	Primary busbar centered No return busbar considered ^{4) 6)}
Delay time @ 10 % of the final output value I_{PN} step	t_{D10}	μs			0.3 0.4	SBlx version @ 100 A/ μs SUIx version @ 100 A/ μs
Delay time @ 90 % of the final output value I_{PN} step	t_{D90}	μs			0.3 0.4	SBlx version @ 100 A/ μs SUIx version @ 100 A/ μs
Frequency bandwidth (-3 dB)	BW	kHz		1000		See ⁵⁾
RMS noise current spectral density referred to primary 100 Hz ... 100 kHz 100 kHz ... 1 MHz	i_{no}	$\text{mA}/\sqrt{\text{Hz}}$			21.1&423 0.7&1.3	FRS xxx-SBI & FRS xxx-SUI
Peak to peak noise current referred to primary: up to 10 kHz up to 100 kHz up to 1 MHz		A		1.4 & 2.9 2.0 & 4.0 2.1 & 4.3		FRS xxx-SBI & FRS xxx-SUI

Notes: ¹⁾ This low power coreless transducer may accept up to I_{Pmax} permanent current; at the only condition of respecting the maximum primary conductor temperature (105 °C)

²⁾ Above 28 V, accuracy performance may change irremediably

³⁾ Rounded, actual value is obtained by the following formula: $\pm I_{PM} \times S_N$

⁴⁾ See [page 11](#) typical influence of the return busbar regarding its position

⁵⁾ The maximum admissible couple of (I_{PM} and frequency) is specified on [page 10](#)

⁶⁾ Transducer may have an additional drift when exposed to high temperature and high humidity:

- A drift of 1.7 % could be seen after an exposure at 85 °C /85 % during 1000 hours

- This drift is reversible when the transducer goes back to normal conditions.

Electrical data FRS 1500-Sxlx

 At $T_A = 25\text{ °C}$, $U_C = +24\text{ V}$, $R_M = 100\text{ }\Omega$, unless otherwise noted (see Min, Max, typ, definition paragraph in [page 9](#)).

Parameter	Symbol	Unit	Min	Typ	Max	Comment
Primary nominal current	I_{PN}	A		1500		See ¹⁾
Primary current, measuring range	I_{PM}	A	-4500 0		4500 4500	SBlx version SUIx version
Supply voltage	U_C	V	10	12 or 24	28	See ²⁾
Current consumption	I_C	mA		$120 + 1.2 \times I_{out}$ $60 + 1.2 \times I_{out}$	180 120	@ $U_C = 12\text{ V DC}$ @ $U_C = 24\text{ V DC}$
Output current range @ $\pm I_{PM}$ ³⁾ @ 0 ... I_{PM}	I_{out}	mA	4 4		20 20	SBlx version $I_{out} = 12\text{ mA}$ @ $I_p = 0$ SUIx version $I_{out} = 4\text{ mA}$ @ $I_p = 0$
Measuring resistance	R_M	Ω	10	100	240	
Electrical offset current referred to primary	I_{OE}	A	-6.8		6.8	
Temperature coefficient of I_{OE} referred to primary	TCI_{OE}	mA/K	-600 -450		600 450	-40 °C ... 25 °C 25 °C ... 85 °C
Nominal sensitivity	S_N	$\mu\text{A/A}$		1.778 3.556		SBlx version SUIx version
Magnetic offset current (@ I_{PN}) referred to primary	I_{OM}	A		none		No magnetic core inside, OLCI technology
Temperature coefficient of S	TCS	ppm/K	-120		120	-40 °C ... +85 °C
Linearity error 0 ... I_{PM}	ϵ_L	% of I_{PM}	-0.35		0.35	
Sum of sensitivity & Linearity error 0 ... I_{PM}	ϵ_{SL}	% of I_{PM}	-0.5		0.5	Primary busbar centered No return busbar considered ^{4) 6)}
Total error @ 25 °C @ $I_p = 0$ @ $I_p = \pm I_{PM}$	ϵ_{tot}	% of I_{PM}	-0.15 -0.65		0.15 0.65	Primary busbar centered No return busbar considered ^{4) 6)}
Total error @ -40 °C @ $I_p = 0$ @ $I_p = \pm I_{PM}$	ϵ_{tot}	% of I_{PM}	-0.99 -1.55		0.99 1.55	Primary busbar centered No return busbar considered ^{4) 6)}
Total error @ 85 °C @ $I_p = 0$ @ $I_p = \pm I_{PM}$	ϵ_{tot}	% of I_{PM}	-0.62 -1.25		0.62 1.25	Primary busbar centered No return busbar considered ^{4) 6)}
Delay time @ 10 % of the final output value I_{PN} step	t_{D10}	μs			0.3 0.4	SBlx version @ 100 A/ μs SUIx version @ 100 A/ μs
Delay time @ 90 % of the final output value I_{PN} step	t_{D90}	μs			0.3 0.4	SBlx version @ 100 A/ μs SUIx version @ 100 A/ μs
Frequency bandwidth (-3 dB)	BW	kHz		1000		See ⁵⁾
RMS noise current spectral density referred to primary 100 Hz ... 100 kHz 100 kHz ... 1 MHz	i_{no}	$\text{mA}/\sqrt{\text{Hz}}$			330&660 0.8&1.7	FRS xxx-SBI & FRS xxx-SUI
Peak to peak noise current referred to primary: up to 10 kHz up to 100 kHz up to 1 MHz	$I_{no\text{pp}}$	A		1.9 & 3.8 2.5 & 4.9 2.6 & 5.3		FRS xxx-SBI & FRS xxx-SUI

Notes: ¹⁾ This low power coreless transducer may accept up to $I_{P\text{max}}$ permanent current; at the only condition of respecting the maximum primary conductor temperature (105 °C)

²⁾ Above 28 V, accuracy performance may change irremediably

³⁾ Rounded, actual value is obtained by the following formula: $\pm I_{PM} \times S_N$

⁴⁾ See [page 11](#) typical influence of the return busbar regarding its position

⁵⁾ The maximum admissible couple of (I_{PM} and frequency) is specified on [page 10](#)

⁶⁾ Transducer may have an additional drift when exposed to high temperature and high humidity:

- A drift of 1.7 % could be seen after an exposure at 85 °C /85 % during 1000 hours

- This drift is reversible when the transducer goes back to normal conditions.

Electrical data FRS 2000-Sxlx

 At $T_A = 25\text{ °C}$, $U_C = +24\text{ V}$, $R_M = 100\text{ }\Omega$, unless otherwise noted (see Min, Max, typ, definition paragraph in [page 9](#)).

Parameter	Symbol	Unit	Min	Typ	Max	Comment
Primary nominal current	I_{PN}	A		2000		See ¹⁾
Primary current, measuring range	I_{PM}	A	-6000 0		6000 6000	SBlx version SUIx version
Supply voltage	U_C	V	10	12 or 24	28	See ²⁾
Current consumption	I_C	mA		$120 + 1.2 \times I_{out}$ $60 + 1.2 \times I_{out}$	180 120	@ $U_C = 12\text{ V DC}$ @ $U_C = 24\text{ V DC}$
Output current range @ $\pm I_{PM}$ ³⁾ @ 0 ... I_{PM}	I_{out}	mA	4 4		20 20	SBlx version $I_{out} = 12\text{ mA}$ @ $I_p = 0$ SUIx version $I_{out} = 4\text{ mA}$ @ $I_p = 0$
Measuring resistance	R_M	Ω	10	100	240	
Electrical offset current referred to primary	I_{OE}	A	-9		9	
Temperature coefficient of I_{OE} referred to primary	TCI_{OE}	mA/K	-900 -600		900 600	-40 °C ... 25 °C 25 °C ... 85 °C
Nominal sensitivity	S_N	$\mu\text{A/A}$		1.333 2.667		SBlx version SUIx version
Magnetic offset current (@ I_{PN}) referred to primary	I_{OM}	A		none		No magnetic core inside, OLCI technology
Temperature coefficient of S	TCS	ppm/K	-120		120	-40 °C ... +85 °C
Linearity error 0 ... I_{PM}	ϵ_L	% of I_{PM}	-0.35		0.35	
Sum of sensitivity & Linearity error 0 ... I_{PM}	ϵ_{SL}	% of I_{PM}	-0.5		0.5	Primary busbar centered No return busbar considered ^{4) 6)}
Total error @ 25 °C @ $I_p = 0$ @ $I_p = \pm I_{PM}$	ϵ_{tot}	% of I_{PM}	-0.15 -0.65		0.15 0.65	Primary busbar centered No return busbar considered ^{4) 6)}
Total error @ -40 °C @ $I_p = 0$ @ $I_p = \pm I_{PM}$	ϵ_{tot}	% of I_{PM}	-0.99 -1.55		0.99 1.55	Primary busbar centered No return busbar considered ^{4) 6)}
Total error @ 85 °C @ $I_p = 0$ @ $I_p = \pm I_{PM}$	ϵ_{tot}	% of I_{PM}	-0.62 -1.25		0.62 1.25	Primary busbar centered No return busbar considered ^{4) 6)}
Delay time @ 10 % of the final output value I_{PN} step	t_{D10}	μs			0.3 0.4	SBlx version @ 100 A/ μs SUIx version @ 100 A/ μs
Delay time @ 90 % of the final output value I_{PN} step	t_{D90}	μs			0.3 0.4	SBlx version @ 100 A/ μs SUIx version @ 100 A/ μs
Frequency bandwidth (-3 dB)	BW	kHz		1000		See ⁵⁾
RMS noise current spectral density referred to primary 100 Hz ... 100 kHz 100 kHz ... 1 MHz	i_{no}	mA/ $\sqrt{\text{Hz}}$			39.0 & 77.9 0.9 & 1.8	FRS xxx-SBI & FRS xxx-SUI
Peak to peak noise current referred to primary: up to 10 kHz up to 100 kHz up to 1 MHz	$I_{no pp}$	A		2.1 & 4.3 2.7 & 5.4 2.9 & 5.8		FRS xxx-SBI & FRS xxx-SUI

- Notes:**
- ¹⁾ This low power coreless transducer may accept up to I_{Pmax} permanent current; at the only condition of respecting the maximum primary conductor temperature (105 °C)
 - ²⁾ Above 28 V, accuracy performance may change irremediably
 - ³⁾ Rounded, actual value is obtained by the following formula: $\pm I_{PM} \times S_N$
 - ⁴⁾ See [page 11](#) typical influence of the return busbar regarding its position
 - ⁵⁾ The maximum admissible couple of (I_{PM} and frequency) is specified on [page 10](#)
 - ⁶⁾ Transducer may have an additional drift when exposed to high temperature and high humidity:
 - A drift of 1.7 % could be seen after an exposure at 85 °C /85 % during 1000 hours
 - This drift is reversible when the transducer goes back to normal conditions.

Electrical data FRS 2500-Sxlx

 At $T_A = 25\text{ °C}$, $U_C = +24\text{ V}$, $R_M = 100\ \Omega$, unless otherwise noted (see Min, Max, typ, definition paragraph in [page 9](#)).

Parameter	Symbol	Unit	Min	Typ	Max	Comment
Primary nominal current	I_{PN}	A		2500		See ¹⁾
Primary current, measuring range	I_{PM}	A	-7500 0		7500 7500	SBlx version SUIx version
Supply voltage	U_C	V	10	12 or 24	28	See ²⁾
Current consumption	I_C	mA		$120 + 1.2 \times I_{out}$ $60 + 1.2 \times I_{out}$	180 120	@ $U_C = 12\text{ V DC}$ @ $U_C = 24\text{ V DC}$
Output current range @ $\pm I_{PM}$ ³⁾ @ 0 ... I_{PM}	I_{out}	mA	4 4		20 20	SBlx version $I_{out} = 12\text{ mA}$ @ $I_p = 0$ SUIx version $I_{out} = 4\text{ mA}$ @ $I_p = 0$
Measuring resistance	R_M	Ω	0	100	240	
Electrical offset current referred to primary	I_{OE}	A	-11.3		11.3	
Temperature coefficient of I_{OE} referred to primary	TCI_{OE}	mA/K	-1125 -750		1125 750	-40 °C ... 25 °C 25 °C ... 85 °C
Nominal sensitivity	S_N	$\mu\text{A/A}$		1.067 2.133		SBlx version SUIx version
Magnetic offset current (@ I_{PN}) referred to primary	I_{OM}	A		none		No magnetic core inside, OLCI technology
Temperature coefficient of S	TCS	ppm/K	-120		120	-40 °C ... +85 °C
Linearity error 0 ... I_{PM}	ϵ_L	% of I_{PM}	-0.35		0.35	
Sum of sensitivity & Linearity error 0 ... I_{PM}	ϵ_{SL}	% of I_{PM}	-0.5		0.5	Primary busbar centered No return busbar considered ^{4) 6)}
Total error @ 25 °C @ $I_p = 0$ @ $I_p = \pm I_{PM}$	ϵ_{tot}	% of I_{PM}	-0.15 -0.65		0.15 0.65	Primary busbar centered No return busbar considered ^{4) 6)}
Total error @ -40 °C @ $I_p = 0$ @ $I_p = \pm I_{PM}$	ϵ_{tot}	% of I_{PM}	-0.99 -1.55		0.99 1.55	Primary busbar centered No return busbar considered ^{4) 6)}
Total error @ 85 °C @ $I_p = 0$ @ $I_p = \pm I_{PM}$	ϵ_{tot}	% of I_{PM}	-0.62 -1.25		0.62 1.25	Primary busbar centered No return busbar considered ^{4) 6)}
Delay time @ 10 % of the final output value I_{PN} step	t_{D10}	μs			0.3 0.4	SBlx version @ 100 A/ μs SUIx version @ 100 A/ μs
Delay time @ 90 % of the final output value I_{PN} step	t_{D90}	μs			0.3 0.4	SBlx version @ 100 A/ μs SUIx version @ 100 A/ μs
Frequency bandwidth (-3 dB)	BW	kHz		1000		See ⁵⁾
RMS noise current spectral density referred to primary 100 Hz ... 100 kHz 100 kHz ... 1 MHz	i_{no}	$\text{mA}/\sqrt{\text{Hz}}$			425&850 1.0&1.9	FRS xxx-SBI & FRS xxx-SUI
Peak to peak noise current referred to primary: up to 10 kHz up to 100 kHz up to 1 MHz	$I_{no\ pp}$	mA		2.3 & 4.6 2.9 & 5.7 3.1 & 6.1		FRS xxx-SBI & FRS xxx-SUI

- Notes:** ¹⁾ This low power coreless transducer may accept up to $I_{P\max}$ permanent current; at the only condition of respecting the maximum primary conductor temperature (105 °C)
- ²⁾ Above 28 V, accuracy performance may change irremediably
- ³⁾ Rounded, actual value is obtained by the following formula: $\pm I_{PM} \times S_N$
- ⁴⁾ See [page 11](#) typical influence of the return busbar regarding its position
- ⁵⁾ The maximum admissible couple of (I_{PM} and frequency) is specified on [page 10](#)
- ⁶⁾ Transducer may have an additional drift when exposed to high temperature and high humidity:
- A drift of 1.7 % could be seen after an exposure at 85 °C /85 % during 1000 hours
- This drift is reversible when the transducer goes back to normal conditions.

Electrical data FRS 3000-Sxlx

 At $T_A = 25\text{ °C}$, $U_C = +24\text{ V}$, $R_M = 100\text{ }\Omega$, unless otherwise noted (see Min, Max, typ, definition paragraph in [page 9](#)).

Parameter	Symbol	Unit	Min	Typ	Max	Comment
Primary nominal current	I_{PN}	A		3000		See ¹⁾
Primary current, measuring range	I_{PM}	A	-9000 0		9000 9000	SBlx version SUIx version
Supply voltage	U_C	V	10	12 or 24	28	See ²⁾
Current consumption	I_C	mA		$120 + 1.2 \times I_{out}$ $60 + 1.2 \times I_{out}$	180 120	@ $U_C = 12\text{ V DC}$ @ $U_C = 24\text{ V DC}$
Output current range @ $\pm I_{PM}$ ³⁾ @ 0 ... I_{PM}	I_{out}	mA	4 4		20 20	SBlx version $I_{out} = 12\text{ mA}$ @ $I_p = 0$ SUIx version $I_{out} = 4\text{ mA}$ @ $I_p = 0$
Measuring resistance	R_M	Ω	0	100	240	
Electrical offset current referred to primary	I_{OE}	A	-13.5		13.5	
Temperature coefficient of I_{OE} referred to primary	TCI_{OE}	mA/K	-1350 -900		1350 900	-40 °C ... 25 °C 25 °C ... 85 °C
Nominal sensitivity	S_N	$\mu\text{A/A}$		0.889 1.778		SBlx version SUIx version
Magnetic offset current (@ I_{PN}) referred to primary	I_{OM}	A		none		No magnetic core inside, OLCI technology
Temperature coefficient of S	TCS	ppm/K	-120		120	-40 °C ... +85 °C
Linearity error 0 ... I_{PM}	ϵ_L	% of I_{PM}	-0.35		0.35	
Sum of sensitivity & Linearity error 0 ... I_{PM}	ϵ_{SL}	% of I_{PM}	-0.5		0.5	Primary busbar centered No return busbar considered ^{4) 6)}
Total error @ 25 °C @ $I_p = 0$ @ $I_p = \pm I_{PM}$	ϵ_{tot}	% of I_{PM}	-0.15 -0.65		0.15 0.65	Primary busbar centered No return busbar considered ^{4) 6)}
Total error @ -40 °C @ $I_p = 0$ @ $I_p = \pm I_{PM}$	ϵ_{tot}	% of I_{PM}	-0.99 -1.55		0.99 1.55	Primary busbar centered No return busbar considered ^{4) 6)}
Total error @ 85 °C @ $I_p = 0$ @ $I_p = \pm I_{PM}$	ϵ_{tot}	% of I_{PM}	-0.62 -1.25		0.62 1.25	Primary busbar centered No return busbar considered ^{4) 6)}
Delay time @ 10 % of the final output value I_{PN} step	t_{D10}	μs			0.3 0.4	SBlx version @ 100 A/ μs SUIx version @ 100 A/ μs
Delay time @ 90 % of the final output value I_{PN} step	t_{D90}	μs			0.3 0.4	SBlx version @ 100 A/ μs SUIx version @ 100 A/ μs
Frequency bandwidth (-3 dB)	BW	kHz		1000		See ⁵⁾
RMS noise current spectral density referred to primary 100 Hz ... 100 kHz 100 kHz ... 1 MHz	i_{no}	$\text{mA}/\sqrt{\text{Hz}}$			44.9 & 89.8 1.0 & 2.0	FRS xxx-SBI & FRS xxx-SUI
Peak to peak noise current referred to primary: up to 10 kHz up to 100 kHz up to 1 MHz	$I_{no pp}$	A		2.4 & 4.8 3.0 & 5.9 3.2 & 6.3		FRS xxx-SBI & FRS xxx-SUI

- Notes:** ¹⁾ This low power coreless transducer may accept up to I_{Pmax} permanent current; at the only condition of respecting the maximum primary conductor temperature (105 °C)
- ²⁾ Above 28 V, accuracy performance may change irremediably
- ³⁾ Rounded, actual value is obtained by the following formula: $\pm I_{PM} \times S_N$
- ⁴⁾ See [page 11](#) typical influence of the return busbar regarding its position
- ⁵⁾ The maximum admissible couple of (I_{PM} and frequency) is specified on [page 10](#)
- ⁶⁾ Transducer may have an additional drift when exposed to high temperature and high humidity:
- A drift of 1.7 % could be seen after an exposure at 85 °C /85 % during 1000 hours
- This drift is reversible when the transducer goes back to normal conditions.

Definition of typical, minimum and maximum values

Minimum and maximum values for specified limiting and safety conditions have to be understood as such as well as values shown in “typical” graphs.

On the other hand, measured values are part of a statistical distribution that can be specified by an interval with upper and lower limits and a probability for measured values to lie within this interval.

Unless otherwise stated (e.g. “100 % tested”), the LEM definition for such intervals designated with “min” and “max” is that the probability for values of samples to lie in this interval is 99.73 %.

For a normal (Gaussian) distribution, this corresponds to an interval between -3 sigma and $+3$ sigma. If “typical” values are not obviously mean or average values, those values are defined to delimit intervals with a probability of 68.27 %, corresponding to an interval between $-\text{sigma}$ and $+\text{sigma}$ for a normal distribution.

Typical, maximal and minimal values are determined during the initial characterization of the product.

Maximum admissible couple of (I_{PM} & Frequency)

Typical input/output characteristics

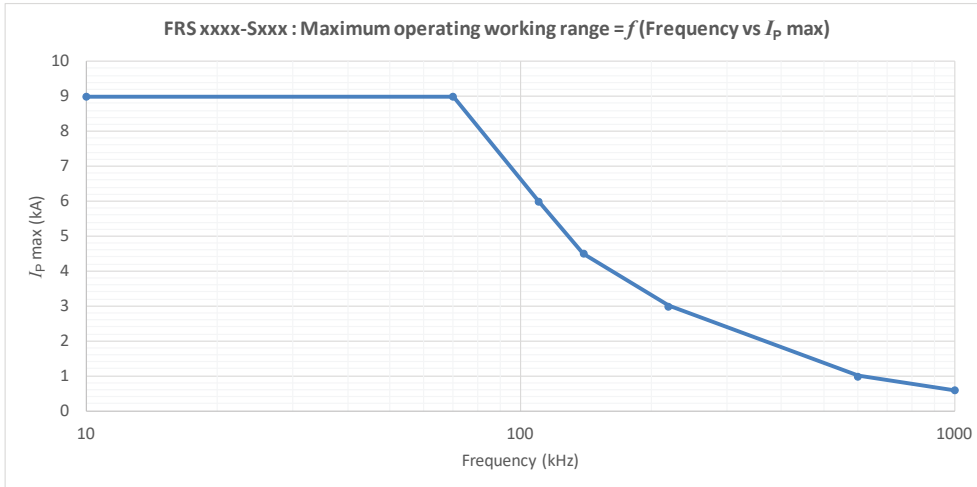

Figure 1: Bi-polar output current I_{out} VS primary current I_p

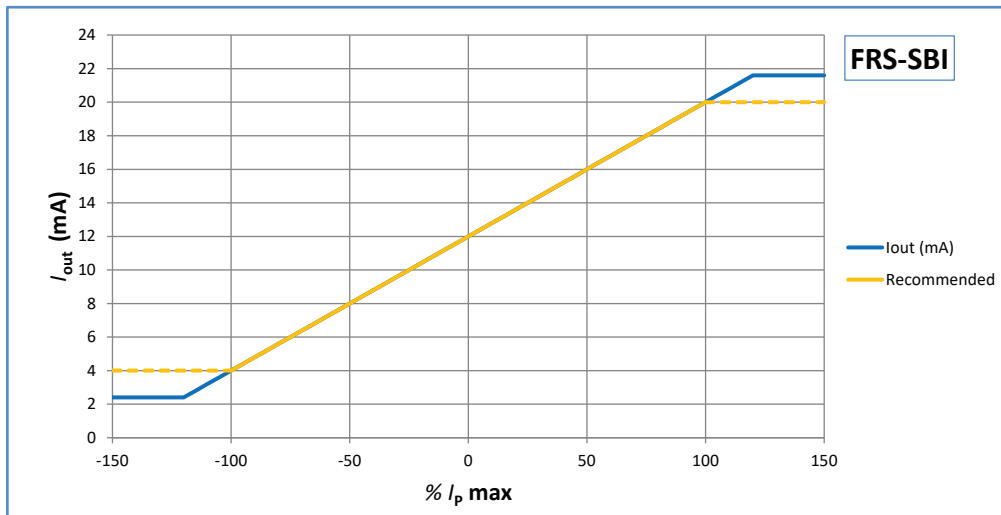
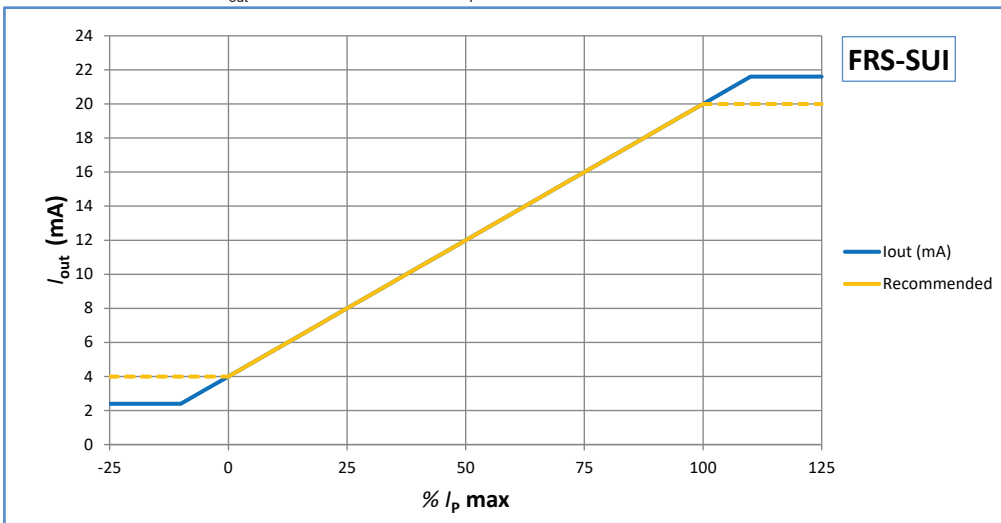
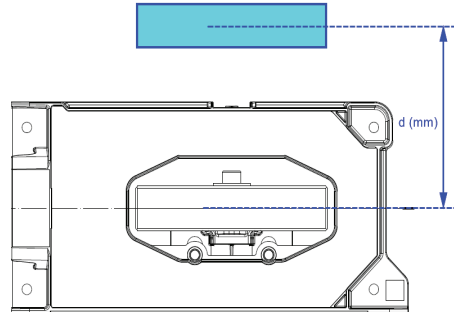
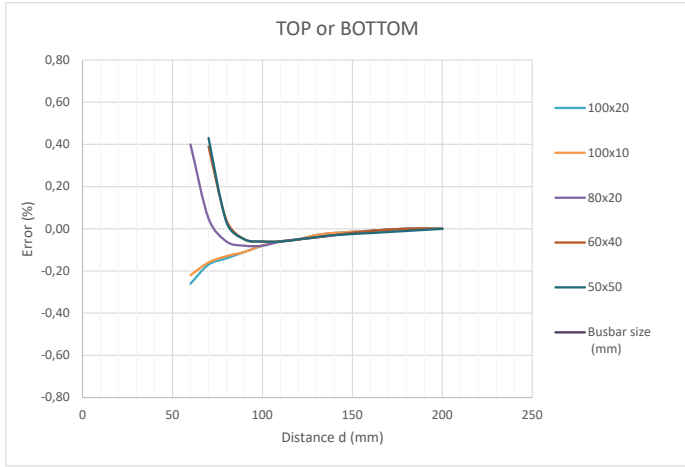

Figure 2: Uni-polar output current I_{out} VS primary current I_p



Typical additional error due to return busbar layout and distance

Busbar on TOP or BOTTOM



Busbar on the side (LEFT or RIGHT)

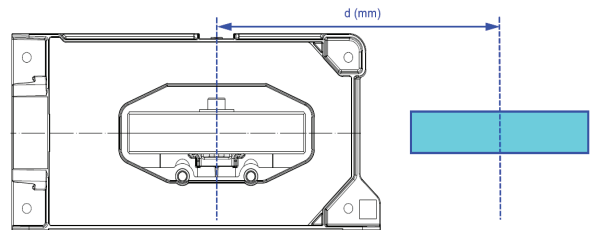
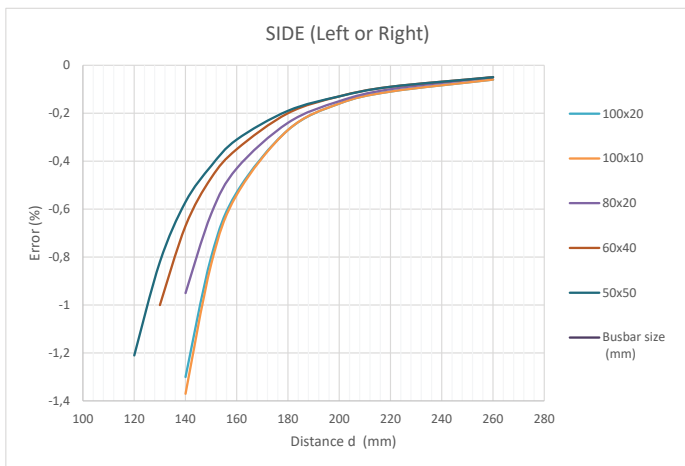

FRS-Sxlx series: name and codification

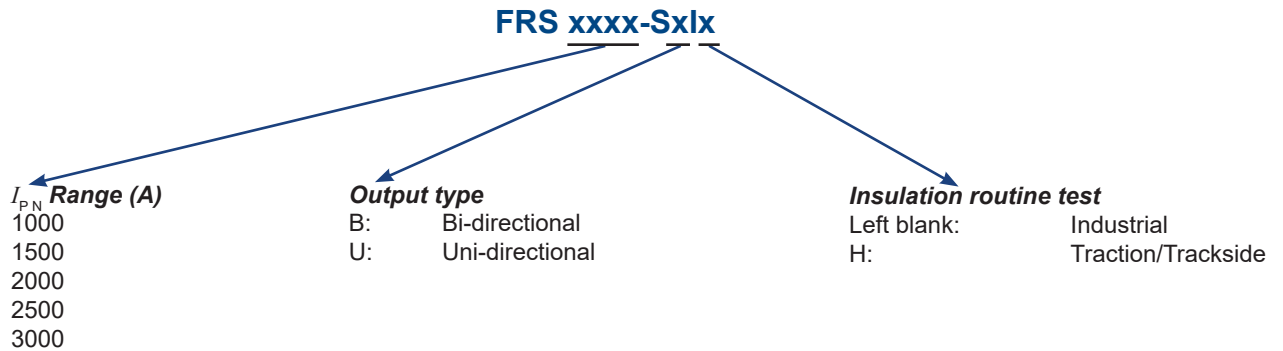

FRS-Sxlx series: ordering

Name	Part numbers
FRS 1000-SBI	90.Y9.60.001.0
FRS 1000-SUI	90.Y9.60.002.0
FRS 1500-SBI	90.Y9.65.003.0
FRS 1500-SUI	90.Y9.65.004.0
FRS 2000-SBI	90.Y9.69.005.0
FRS 2000-SUI	90.Y9.69.006.0
FRS 2500-SBI	90.Y9.70.007.0
FRS 2500-SUI	90.Y9.70.008.0
FRS 3000-SBI	90.Y9.71.009.0
FRS 3000-SUI	90.Y9.71.010.0
FRS 1000-SBIH	90.Y9.60.011.0
FRS 1000-SUIH	90.Y9.60.012.0
FRS 1500-SBIH	90.Y9.65.013.0
FRS 1500-SUIH	90.Y9.65.014.0
FRS 2000-SBIH	90.Y9.69.015.0
FRS 2000-SUIH	90.Y9.69.016.0
FRS 2500-SBIH	90.Y9.70.017.0
FRS 2500-SUIH	90.Y9.70.018.0
FRS 3000-SBIH	90.Y9.71.019.0
FRS 3000-SUIH	90.Y9.71.020.0

Note: ¹⁾ This is an exhaustive list, to date some references may not yet exist, please contact your local LEM's sales support.

Dimensions (in mm)

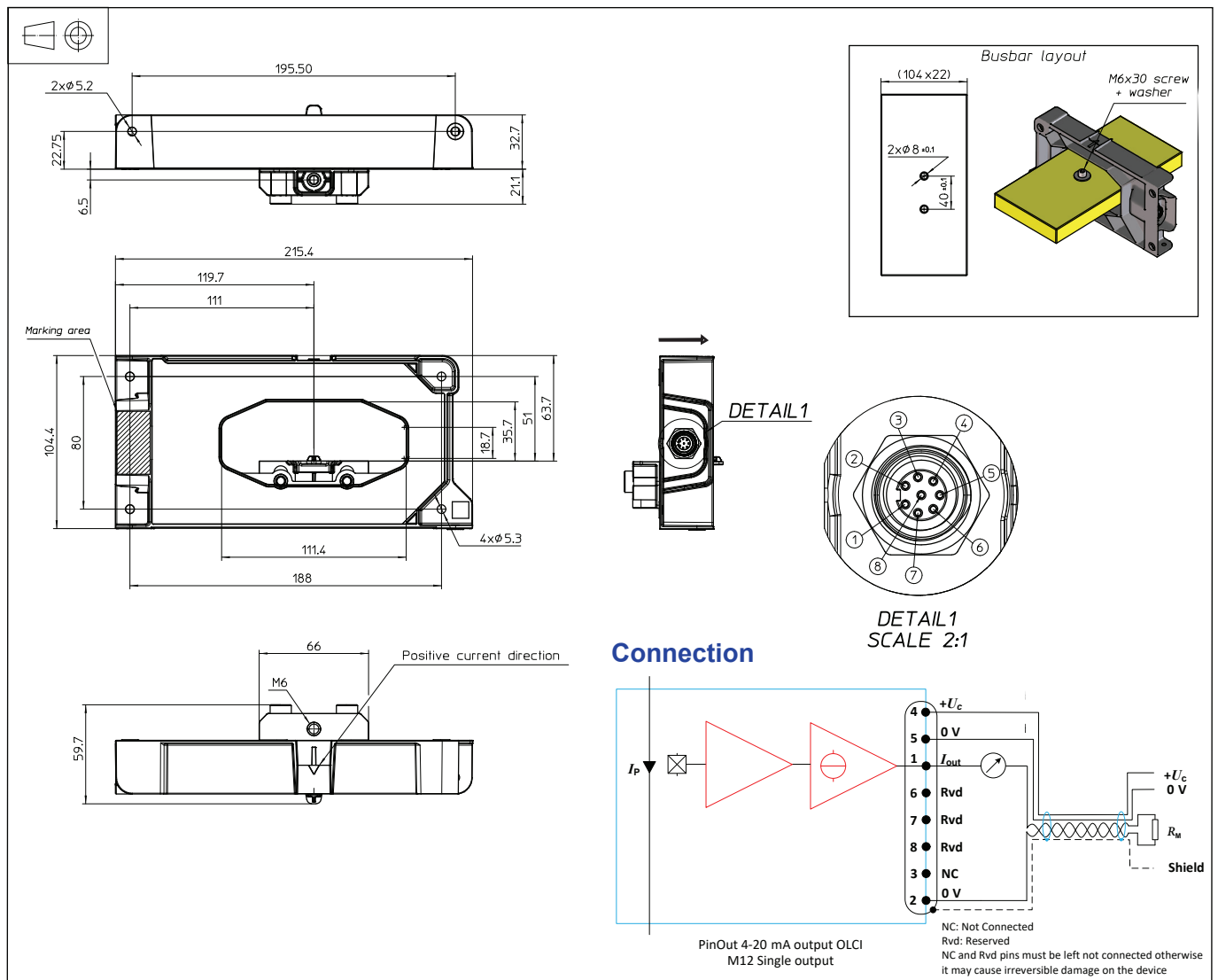

Mechanical characteristics

- General tolerance ± 1 mm
- Aperture for primary conductor 104 mm \times 22 mm (max)
- Transducer fastening
 - Bracket fastening 2 \times M6 (supplied)
 - Busbar fastening 1 \times M6 (not supplied)
 - Recommended fastening torque 6 N·m ± 10 %
- Connection of secondary Use M12 Male/Male, coding A, 8 terminals, shielded

Remarks

- I_{out} is positive when positive I_p flows in direction of the arrow shown on the drawing above.
- Temperature of the primary conductor should not exceed 105 °C.
- Installation of the transducer must be done unless otherwise specified on the datasheet, according to LEM Transducer Generic Mounting Rules. Please refer to LEM document N°ANE120504 available on our Web site: <https://www.lem.com/en/file/3137/download>

Recommandation

When primary and return busbars carry high frequency current it is highly recommended to use a twisted signal pair (pin number 1 & 2).