

For the electronic measurement of current: DC, AC, pulsed..., with galvanic separation between the primary and the secondary circuit.

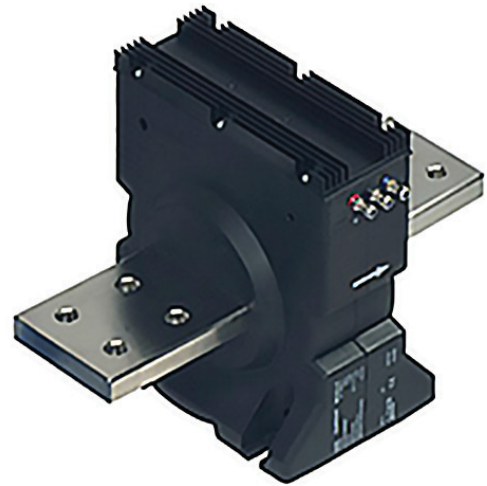

Features

- Bipolar and insulated current measurement
- Current output
- Closed loop (compensated) current transducer using the Hall effect
- Panel mounting.

Advantages

- Excellent accuracy
- Very good linearity
- Low temperature drift
- Optimized delay time
- Wide frequency bandwidth
- No insertion losses
- High immunity to external interference
- Current overload capability.

Applications

- AC variable speed and servo motor drives
- Static converters for DC motor drives
- Battery supplied applications
- Uninterruptible Power Supplies (UPS)
- Switched Mode Power Supplies (SMPS)
- Power supplies for welding applications.

Standards

- IEC 61010-1: 2016
- EN 61326-1: 2012.

Application Domain

- Industrial.

Safety



Caution

If the device is used in a way that is not specified by the manufacturer, the protection provided by the device may be compromised. Always inspect the electronics unit and connecting cable before using this product and do not use it if damaged. Mounting assembly shall guarantee the maximum primary conductor temperature, fulfill clearance and creepage distance, minimize electric and magnetic coupling, and unless otherwise specified can be mounted in any orientation.



Caution, risk of electrical shock

This transducer must be used in limited-energy secondary circuits SELV according to IEC 61010-1, in electric/electronic equipment with respect to applicable standards and safety requirements in accordance with the manufacturer's operating specifications.

Use caution during installation and use of this product; certain parts of the module can carry hazardous voltages and high currents (e.g. power supply, primary conductor).

Ignoring this warning can lead to injury and and/or cause serious damage.

De-energize all circuits and hazardous live parts before installing the product.

All installations, maintenance, servicing operations and use must be carried out by trained and qualified personnel practicing applicable safety precautions.

This transducer is a build-in device, whose hazardous live parts must be inaccessible after installation.

This transducer must be mounted in a suitable end-enclosure.

Besides make sure to have a distance of minimum 30 mm between the primary terminals of the transducer and other neighboring components.

Main supply must be able to be disconnected.

Always inspect the current transducer for damage before using this product.

Never connect or disconnect the external power supply while the primary circuit is connected to live parts.

Never connect the output to any equipment with a common mode voltage to earth greater than 30 V.

Always wear protective clothing and gloves if hazardous live parts are present in the installation where the measurement is carried out.

This transducer is a built-in device, not intended to be cleaned with any product. Nevertheless if the user must implement cleaning or washing process, validation of the cleaning program has to be done by himself.



ESD susceptibility

The product is susceptible to be damaged from an ESD event and the personnel should be grounded when handling it.

Do not dispose of this product as unsorted municipal waste. Contact a qualified recycler for disposal.

Absolute maximum ratings

Parameter	Symbol	Unit	Value
Maximum supply voltage (working) (-25 ... 70 °C)	$\pm U_{C\max}$	V	± 25.2
Maximum primary conductor temperature	$T_{B\max}$	°C	100

Absolute maximum ratings apply at 25 °C unless otherwise noted.
 Stresses above these ratings may cause permanent damage.
 Exposure to absolute maximum ratings for extended periods may degrade reliability.

Environmental and mechanical characteristics

Parameter	Symbol	Unit	Min	Typ	Max	Comment
Ambient operating temperature	T_A	°C	-25		70	
Ambient storage temperature	$T_{A\text{st}}$	°C	-40		85	
Relative humidity	RH	%	20		80	non-condensing
Mass	m	g		13000		
Altitude		m			2000 ¹⁾	

Note: ¹⁾ Insulation coordination at 2000 m.

Insulation coordination

Parameter	Symbol	Unit	≤ Value	Comment
RMS voltage for AC insulation test, 50 Hz, 1 min	U_d	kV	6	
Impulse withstand voltage 1.2/50 μs	U_{Ni}	kV	17.7	According to IEC 61010-1
Partial discharge RMS test voltage ($q_m < 10$ pC)	U_t	V	5760	Test carried out with a non insulated bar and completely filling the primary hole. According to IEC 61287-1 (not performed on serial test)
Clearance (pri. - sec.)	d_{Cl}	mm	116.8	Shortest distance through air
Creepage distance (pri. - sec.)	d_{Cp}	mm	116.8	Shortest path along device body
Case material	-	-	V0	According to UL 94
Comparative tracking index	CTI		600	Material group I
Application example RMS voltage line-to-neutral		V	> 1500	Basic insulation according to IEC 60664-1 CAT III, PD2
Application example RMS voltage line-to-neutral		V	1000	Reinforced insulation according to IEC 60664-1 CAT III, PD2

Electrical data

At $T_A = 25\text{ °C}$ unless otherwise noted (see Min, Max, typ, definition paragraph).

Parameter	Symbol	Unit	Min	Typ	Max	Comment
Primary nominal DC current (continuous)	I_{PNDC}	A	-4000		4000	
Primary nominal AC RMS current (continuous)	I_{PNAC}	A	-4000		4000	$f \leq 100\text{ Hz}$
Primary current, measuring range	I_{PM}	A	-6000		6000	With $\pm U_C = \pm 24\text{ V}$ (-5%), $T_A = 70\text{ °C}$, $R_M = 2\ \Omega$; for other conditions, see figure 1
Measuring resistance	R_M	Ω	0			
Secondary nominal RMS current	I_{SN}	mA	-800		800	
Resistance of secondary winding	R_S	Ω	12.5	12.8	13	@ 25 °C ¹⁾
Number of secondary turns	N_S			5000		
DC supply voltage =	U_C	V	± 22.8	± 24	± 25.2	
DC current consumption =	I_C	mA	25	$27 + I_S \times N_P / N_S$	29	@ $U_C = \pm 24\text{ V}$ @ 25 °C
Total error	ϵ_{tot}	%			± 0.5 ± 0.8	@ 25 °C (@ I_{PN}) @ $-25 \dots 70\text{ °C}$ (@ I_{PN})
Electrical offset current	I_{OE}	mA			± 0.8	@ 25 °C (@ $I_P = 0$)
Temperature variation of I_{OE}	I_{OT}	mA		± 0.6	± 0.8	referred to 25 °C
Magnetic offset current	I_{OM}	mA		0.2		after $3 \times I_{PN}$ @ 25 °C
Linearity error	ϵ_L	% of I_{PN}			< 0.1 < 0.2	@ 25 °C @ $-25\text{ °C} \dots 70\text{ °C}$
RMS noise 1 Hz ... 10 MHz referred to primary	I_{no}	mA		90		see figure 4
Delay time to 10 % of the final output value $I_{PN\text{ step}}$	t_{D10}	μs		< 1		With $di/dt > 50\text{ A}/\mu\text{s}$ See figure 2
Delay time to 90 % of the final output value $I_{PN\text{ step}}$	t_{D90}	μs		< 1		With $di/dt > 50\text{ A}/\mu\text{s}$ See figure 2
Frequency bandwidth (-1 dB)	BW	kHz		10		With $\pm U_C = \pm 24\text{ V}$, $T_A = 25\text{ °C}$, primary return twisted on back side; see figure 5
Frequency bandwidth (-3 dB)				130		

Note: ¹⁾ $R_S(T_A) = R_S \times (1 + 0.004 \times (T_A + \Delta\text{Temp} - 25))$ estimated temperature increase @ I_{PN} is $\Delta\text{Temp} = 15\text{ °C}$.

Definition of typical, minimum and maximum values

Minimum and maximum values for specified limiting and safety conditions have to be understood as such as well as values shown in "typical" graphs.

On the other hand, measured values are part of a statistical distribution that can be specified by an interval with upper and lower limits and a probability for measured values to lie within this interval.

Unless otherwise stated (e.g. "100 % tested"), the LEM definition for such intervals designated with "min" and "max" is that the probability for values of samples to lie in this interval is 99.73 %.

For a normal (Gaussian) distribution, this corresponds to an interval between -3 sigma and +3 sigma. If "typical" values are not obviously mean or average values, those values are defined to delimit intervals with a probability of 68.27 %, corresponding to an interval between -sigma and +sigma for a normal distribution.

Typical, maximal and minimal values are determined during the initial characterization of the product.

Typical performance characteristics

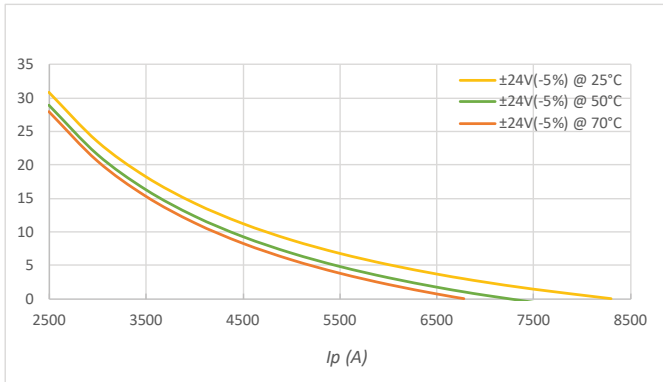

Figure 1: Maximum measuring resistance

$$R_{Mmax} = N_S \times \frac{U_{Cmin} - 0.7V}{I_p} - R_{Smax}$$

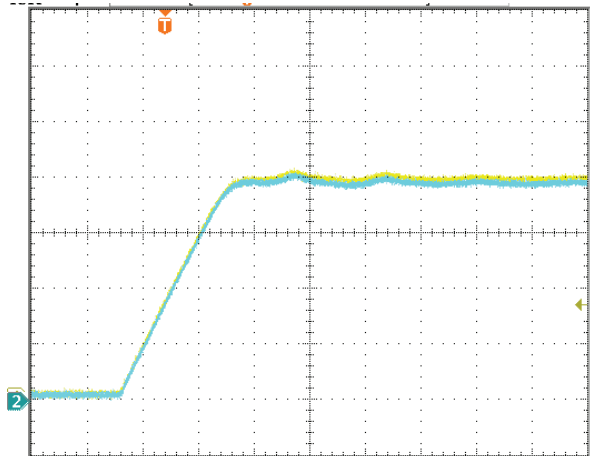

Figure 2: ch1: $I_p = 4000 A$ /ch2: $I_s = 0.2 A/div$, di/dt 50 A/ μs according to the report CA031109 (test done on LT 4000-T/SP42)

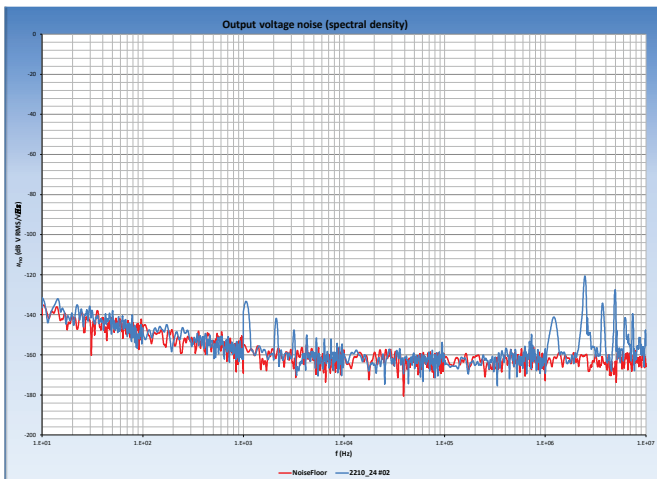

Figure 3: Typical output noise voltage spectral density with $R_M = 1 \text{ Ohm}$ (test done on LT 4000-S/SP35)

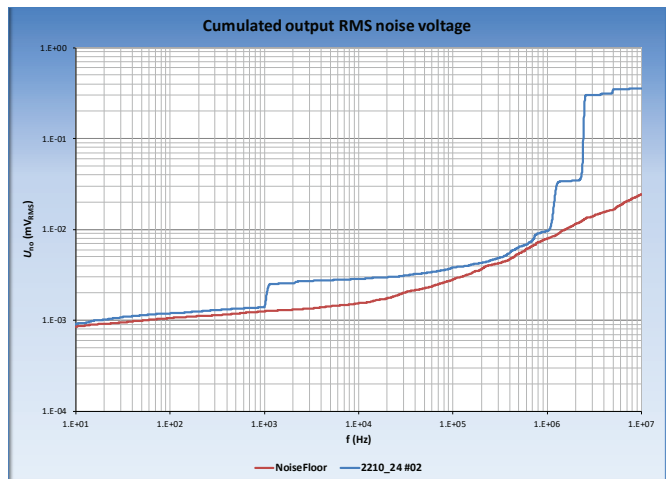

Figure 4: Typical output RMS noise current with $R_M = 1 \text{ Ohm}$ (primary referred) (test done on LT 4000-S/SP35)

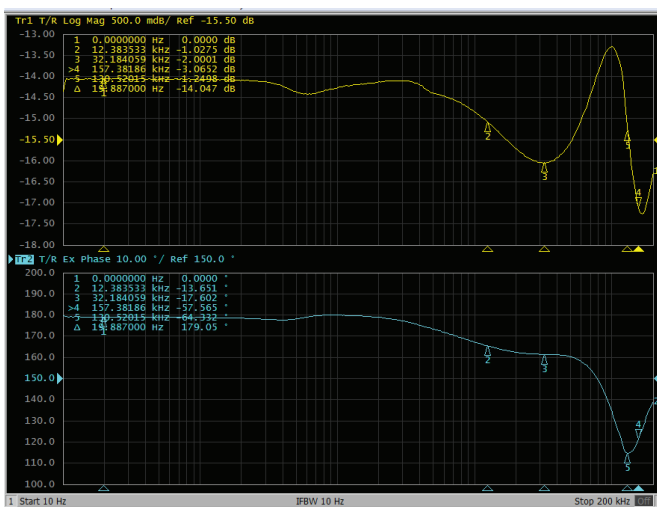

Figure 5: Frequency bandwidth

Terms and definitions

Ampere-turns and amperes

The transducer is sensitive to the primary current linkage θ_p (also called ampere-turns).

$$\theta_p = N_p \cdot I_p$$

Where N_p is the number of primary turn.

Caution: As most applications will use the transducer with only one single primary turn ($N_p = 1$), much of this datasheet is written in terms of primary current instead of current linkages. However, the ampere-turns (A) unit is used to emphasis that current linkages are intended and applicable.

Simplified transducer model

The static model of the transducer with current output at temperature T_A is:

$$I_s = \theta_p \cdot (1 + \varepsilon)$$

In which (referred to primary):

$$\varepsilon \cdot \theta_p = I_{OE} + I_{OT} + \varepsilon_L(\theta_{Pmax}) \cdot \theta_{Pmax} + I_{OM}$$

$\theta_p = N_p \cdot I_p$: primary current linkage (A)

θ_{Pmax} : maximum primary current linkage applied to the transducer

I_s : secondary current (A)

T_A : ambient operating temperature (°C)

I_{OE} : electrical offset current (A)

I_{OM} : magnetic offset current (A)

I_{OT} : temperature variation of I_{OE} (A)

$\varepsilon_L(\theta_{Pmax})$: linearity error for θ_{Pmax}

This model is valid for primary ampere-turns θ_p between $-\theta_{Pmax}$ and $+\theta_{Pmax}$ only.

This is the absolute maximum error. As all errors are independent, a more realistic way to calculate the error would be to use the following formula:

Total error referred to primary

The total error ε_{tot} is the error at $\pm I_{PN}$, relative to the rated value I_{PN} .

$$\varepsilon = \sqrt{\sum_{i=1}^N \varepsilon_i^2}$$

It includes all errors mentioned above

- the electrical offset I_{OE}
- the magnetic offset I_{OM}
- the linearity error ε_L (to I_{PN}).

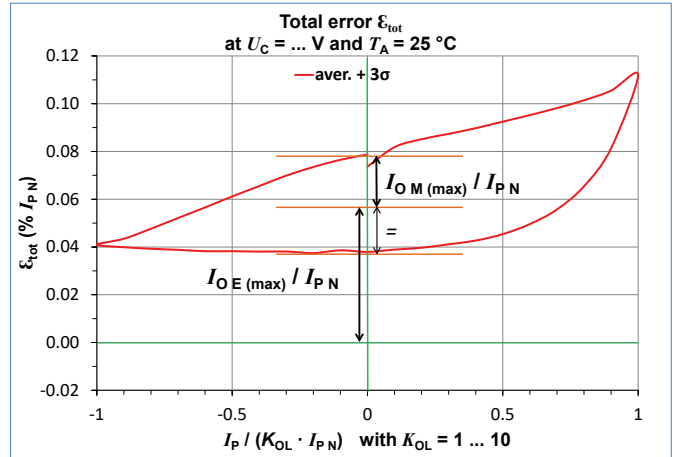

Figure 6: Total error ε_{tot}

Electrical offset referred to primary

Using the current cycle shown in figure 6 the electrical offset current I_{OE} is the residual output referred to primary when the input current is zero.

$$I_{OE} = \frac{I_{P(3)} + I_{P(5)}}{2}$$

The temperature variation I_{OT} of the electrical offset current I_{OE} is the variation of the electrical offset from 25 °C to the considered temperature.

$$I_{OT}(T) = U_{OE}(T) - U_{OE}(25 \text{ °C})$$

Magnetic offset referred to primary

The magnetic offset current I_{OM} is the consequence of a current on the primary side ("memory effect" of the transducer's ferro-magnetic parts). It is measured using the following primary current cycle. I_{OM} depends on the current value $I_p \geq I_{PN}$.

K_{OL} : Overload factor

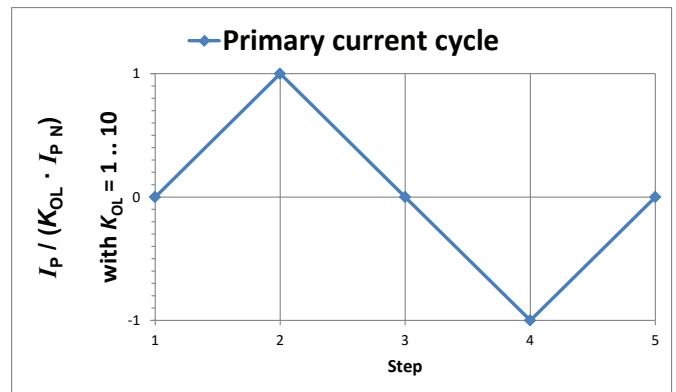

Figure 7: Current cycle used to measure magnetic and electrical offset (transducer supplied)

$$I_{OM} = \frac{I_{P(3)} - I_{P(5)}}{2}$$

Sensitivity and linearity

To measure sensitivity and linearity, the primary current (DC) is cycled from 0 to I_p , then to $-I_p$ and back to 0 (equally spaced $I_p/10$ steps). The linearity error ϵ_L is the maximum positive or negative difference between the measured points and the linear regression line, expressed in % of I_{PN} .

Delay times

The delay time $t_{D,10}$ @ 10 % and the delay time $t_{D,90}$ @ 90 % with respect to the primary are shown in the next figure. Both slightly depend on the primary current di/dt . They are measured at nominal current.

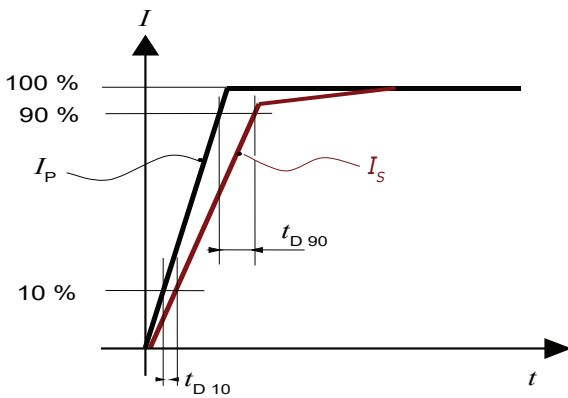
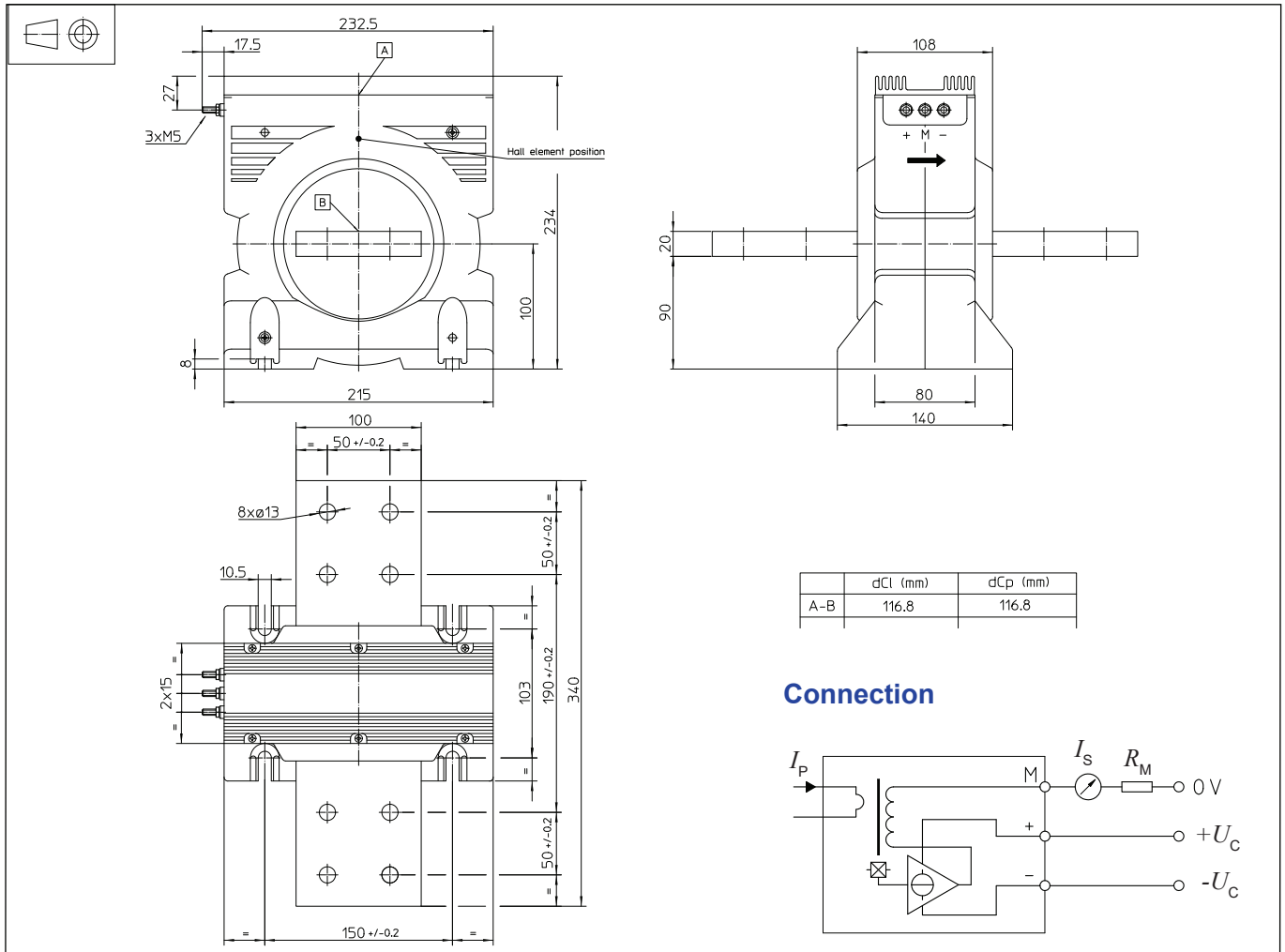
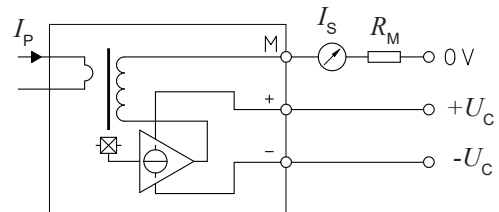

Figure 8: $t_{D,10}$ (delay time @ 10 %) and $t_{D,90}$ (delay time @ 90 %).

Dimensions (in mm)



Connection



Mechanical characteristics

- General tolerance ± 1 mm
- Transducer fastening 4 notches $\varnothing 10.5$ mm
4 x M10 steel screws
Recommended fastening torque 11.5 N·m (± 10 %)
Or
- Connection of primary 8 holes $\varnothing 13$ mm
M12 steel screws
Recommended fastening torque 24.5 N·m (± 10 %)
- Connection of secondary M5 threaded studs
Recommended fastening torque 2.2 N·m (± 10 %)

Remarks

- I_s is positive when I_p flows in the direction of arrow.
- The secondary cables also have to be routed together all the way.
- Installation of the transducer must be done, unless otherwise specified on the datasheet, according to LEM Transducer Generic Mounting Rules. Please refer to LEM document N°ANE120504 available on our Web site:
<https://www.lem.com/en/file/3137/download/>